

NOTES:

- 1. SUBSTRATE:
FUSED SILICA
- 2. ROHS COMPLIANT
- 3. COATING (APPLY ACROSS CLEAR APERTURE)

S1 & S2: 1064 V-COAT
R(ABS) <0.25% @ 1064nm

4. FINE GRIND SURFACE (ADD INK NOTE AS NEEDED)

5. FINE GRIND SURFACE

6. FOCAL LENGTH (EFL): -30.00 mm
BACK FOCAL LENGTH (BFL): -31.37 mm

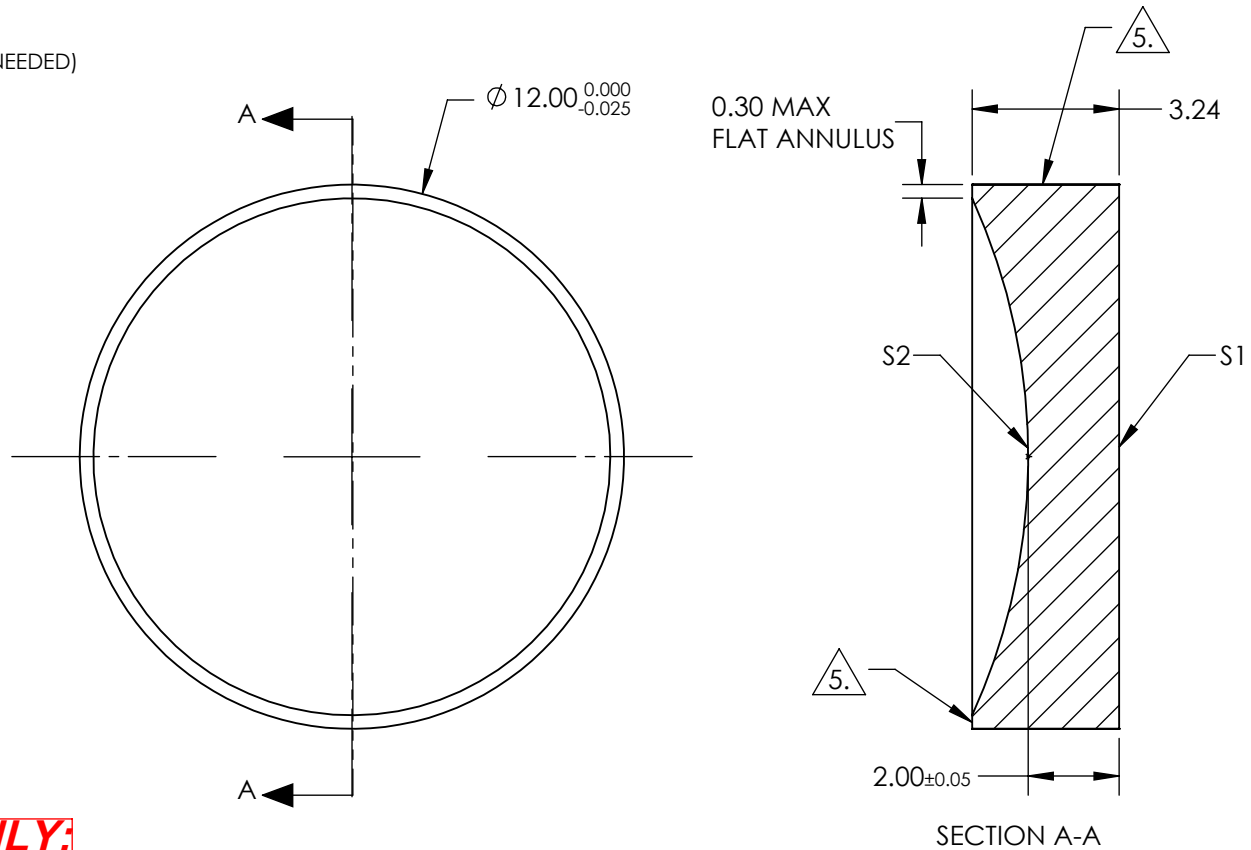

**FOR INFORMATION ONLY:
DO NOT MANUFACTURE
PARTS TO THIS DRAWING**

SPECIFICATIONS SUBJECT TO CHANGE WITHOUT NOTICE
DIMENSIONS ARE FOR REFERENCE ONLY

	S1	S2
SHAPE	CONCAVE	PLANO
RADIUS	-13.75	INFINITY
SURFACE QUALITY	40-20	40-20
CLEAR APERTURE	Ø 11	Ø 11
BEVEL	PROTECTED AS NEEDED	PROTECTED AS NEEDED

THIRD ANGLE PROJECTION

ALL DIMS IN

mm

Edmund Optics®

TITLE

12.0mm Dia. x -30 FL, 1064 V-Coat, UV Plano-Concave Lens

DWG NO

21033

SHEET
1 OF 1