

NOTES:

1. MATERIAL: UV Grade Fused Silica
2. TRANSMITTED WAVEFRONT ERROR: $< \lambda/4$

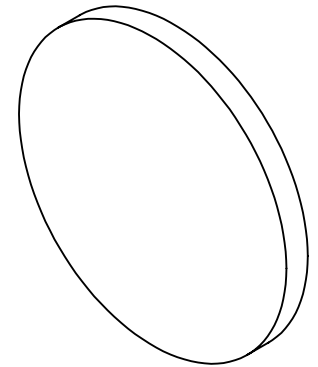
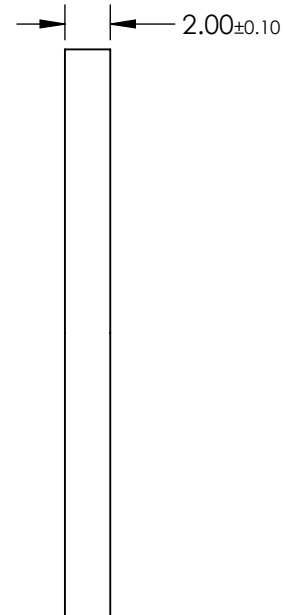
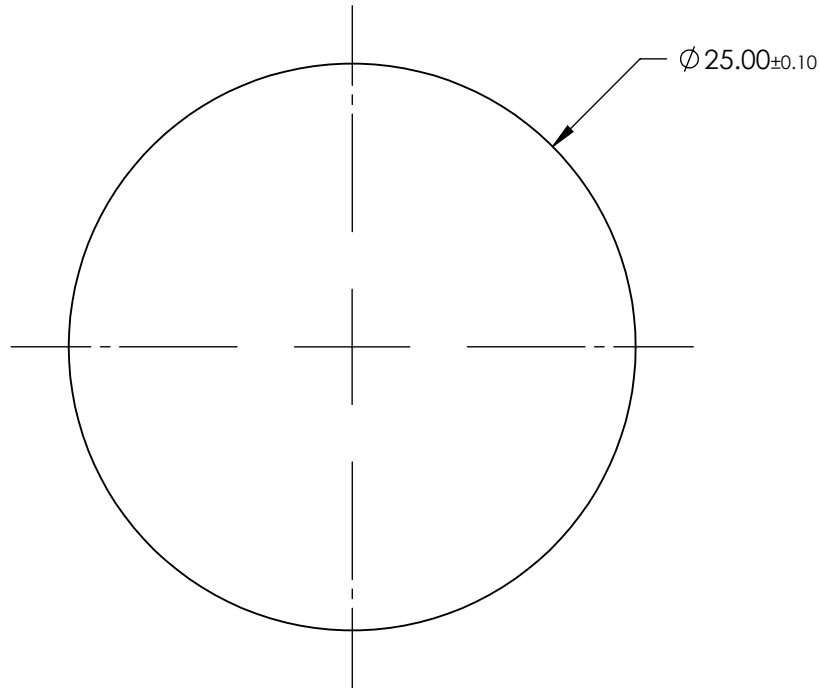

	VALUE
CENTER WAVELENGTH (CWL)	832.00 .00 nm
TRANSMISSION BANDWIDTH (MINIMUM)	37.00 nm
FULL WIDTH HALF MAX (TYPICAL)	45.00 .00 nm
AVERAGE TRANSMISSION OVER BANDWIDTH (MINIMUM)	93 %
BLOCKING WAVELENGTH RANGE	250 - 1100 nm
OD6 BLOCKING RANGE < 3% FROM EDGE OF BANDWIDTH	550 - 794 & 878 - 1075
CLEAR APERTURE (mm)	Ø 22.50
SURFACE QUALITY	60-40
COATING TYPE	HARD COATED
DURABILITY	MIL-C-48497A, SECTION 3.4.1
ENVIRONMENTAL	MIL-STD-810F, SECTION 507.4

**FOR INFORMATION ONLY:
DO NOT MANUFACTURE
PARTS TO THIS DRAWING**

SPECIFICATIONS SUBJECT TO CHANGE WITHOUT NOTICE
DIMENSIONS ARE FOR REFERENCE ONLY

EO® Edmund Optics®

THIRD ANGLE PROJECTION		TITLE	832nm CWL, 25mm Dia, 37nm Bandwidth, Unmounted OD 6 Fluorescence Bandpass Filter	
ALL DIMS IN	mm	DWG NO	18401	SHEET 1 OF 1