

NOTES:

1. SUBSTRATE: Silicon Floatzone (SiFz)
2. RoHS: COMPLIANT

**FOR INFORMATION ONLY:
DO NOT MANUFACTURE
PARTS TO THIS DRAWING**

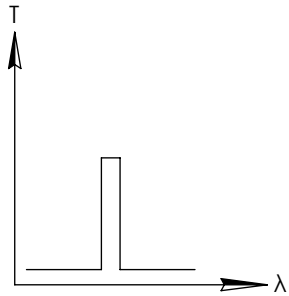
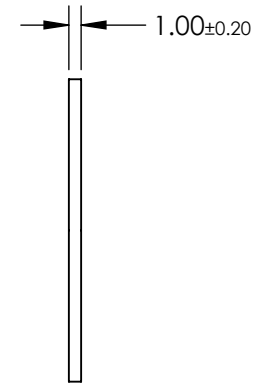
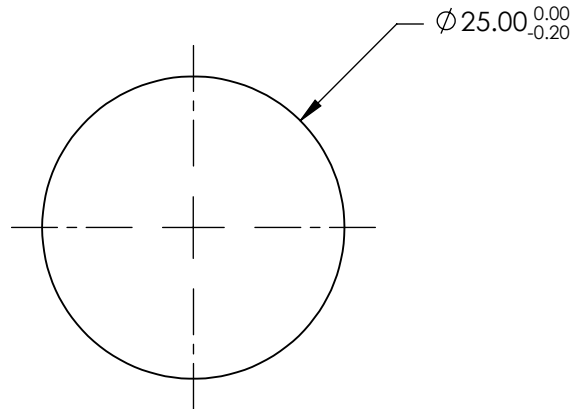
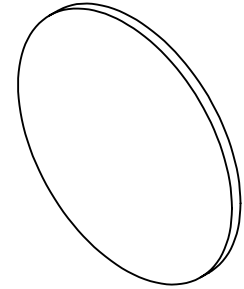

BANDPASS FILTER

SPECIFICATIONS SUBJECT TO CHANGE WITHOUT NOTICE
DIMENSIONS ARE FOR REFERENCE ONLY

	VALUE
SHAPE	PLANO
SURFACE QUALITY	80-50
CENTER WAVELENGTH (μm)	7.00
FULL WIDTH HALF MAX (FWHM) (μm)	0.50±0.05
MIN TRANSMISSION (%)	≥65
CLEAR APERTURE	Ø20.00
BEVEL	PROTECTED AS NEEDED

EO® Edmund Optics®

THIRD ANGLE PROJECTION		TITLE	7.00μm CWL, 25.0mm DIAMETER, 0.50μm FWHM, IR BANDPASS FILTER
ALL DIMS IN	mm	DWG NO	17246
			SHEET 1 OF 1