

NOTES:

1. SUBSTRATE: BOROFLOAT33
2. COATING

DURABILITY:  
 PHYSICAL: MIL-C-48497A, SECTION 3.4.1  
 ENVIRONMENTAL: MIL-STD-810F, SECTION 507.4

PERFORMANCE SPECIFICATIONS @ 0° AOI  
 T(AVG): ≥85% FROM 940 - 1600nm  
 T(AVG): ≤1% FROM 600 - 860nm  
 CUT-ON WAVELENGTH: T(ABS) = 50% @ 900nm ± 18nm

3. ROHS COMPLIANT

**FOR INFORMATION ONLY:  
 DO NOT MANUFACTURE  
 PARTS TO THIS DRAWING**

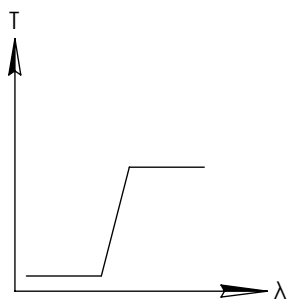
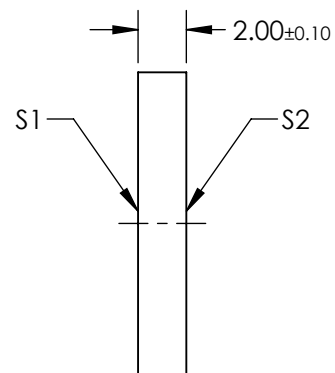
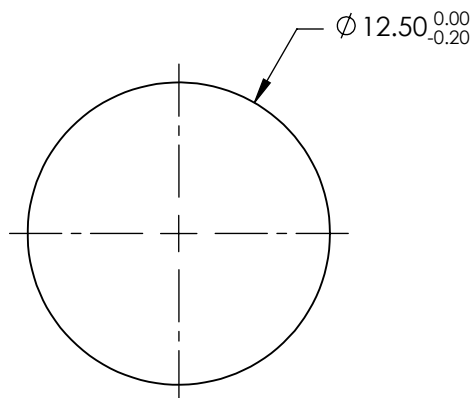
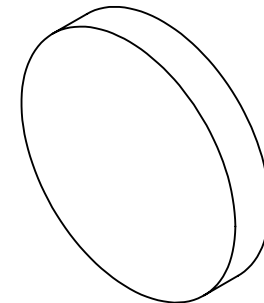

LONGPASS FILTER

SPECIFICATIONS SUBJECT TO CHANGE WITHOUT NOTICE  
 DIMENSIONS ARE FOR REFERENCE ONLY

	S1	S2
SHAPE	PLANO	PLANO
SURFACE QUALITY	60-40	60-40
CLEAR APERTURE	Ø11.25	Ø11.25
BEVEL	PROTECTIVE AS NEEDED	PROTECTIVE AS NEEDED

THIRD ANGLE  
 PROJECTION

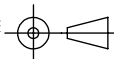

ALL DIMS IN

mm

**EO**® **Edmund Optics**®

TITLE

FILTER OD2 LONGPASS 900nm 12.5mm

DWG NO

15220

SHEET  
 1 OF 1