

NOTES:

1. SUBSTRATE: BOROFLOAT33
2. COATING

DURABILITY:

PHYSICAL: MIL-C-48497A, SECTION 3.4.1
 ENVIRONMENTAL: MIL-STD-810F, SECTION 507.4

PERFORMANCE SPECIFICATIONS @ 0° AOI

T(AVG): ≥85% FROM 780 - 1600nm

T(AVG): ≤1% FROM 500 - 715nm

CUT-ON WAVELENGTH: T(ABS) = 50% @ 750nm ± 15nm

3. ROHS COMPLIANT

**FOR INFORMATION ONLY:
 DO NOT MANUFACTURE
 PARTS TO THIS DRAWING**

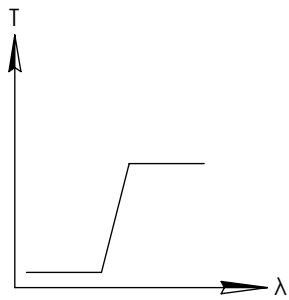
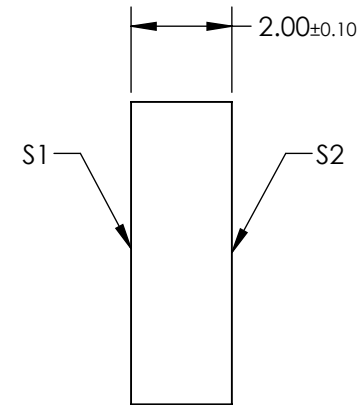
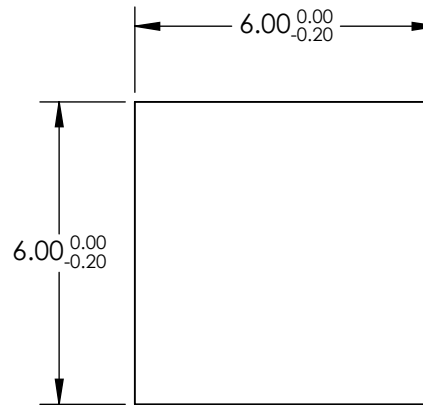

LONGPASS FILTER

SPECIFICATIONS SUBJECT TO CHANGE WITHOUT NOTICE
 DIMENSIONS ARE FOR REFERENCE ONLY



	S1	S2
SHAPE	PLANO	PLANO
SURFACE QUALITY	60-40	60-40
CLEAR APERTURE	5.40 x 5.40	5.40 x 5.40
BEVEL	PROTECTIVE AS NEEDED	PROTECTIVE AS NEEDED

THIRD ANGLE PROJECTION

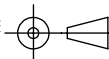

ALL DIMS IN

mm

TITLE	FILTER OD2 LONGPASS 750nm 6mm x 6mm
DWG NO	15205
SHEET	1 OF 1