

NOTES:

1. SUBSTRATE:
SCHOTT NG9

2. FINE GRIND SURFACE

3. COATING SPECIFICATION:
S1 & S2:NONE

4. OPTICAL DENSITY: 2.3

5. TRANSMISSION (%): 0.5% AVERAGE FROM 400-700nm

6. ROHS COMPLIANT

**FOR INFORMATION ONLY:
DO NOT MANUFACTURE
PARTS TO THIS DRAWING**

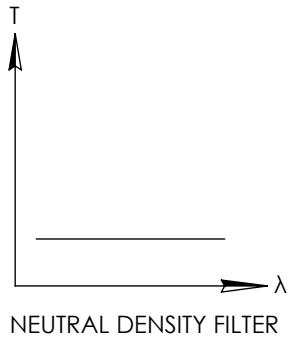
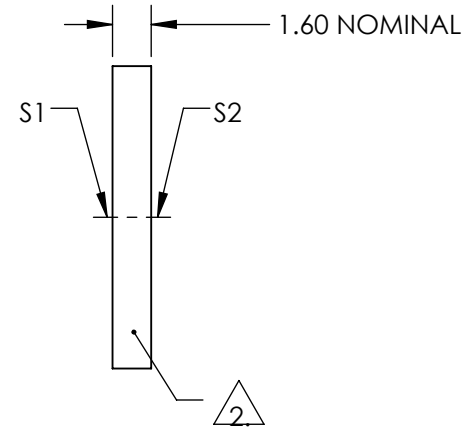
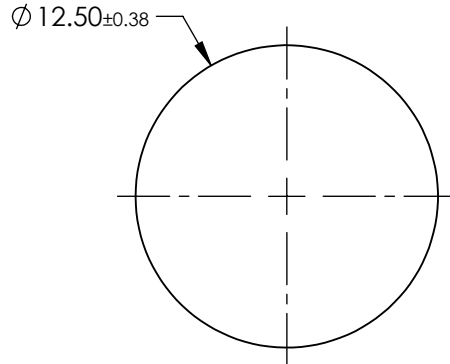
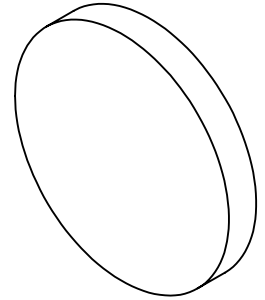

SPECIFICATIONS SUBJECT TO CHANGE WITHOUT NOTICE
DIMENSIONS ARE FOR REFERENCE ONLY

EO® Edmund Optics®

| | | | | | | | |
|-----------------|----------------------|----------------------|------------------------|----|--------|--|-----------------|
| | S1 | S2 | THIRD ANGLE PROJECTION | | TITLE | SCHOTT NG9, 2.3 OD, 12.5mm DIA., ABSORPTIVE ND FILTER | |
| SHAPE | PLANO | PLANO | ALL DIMS IN | mm | DWG NO | 16652 | SHEET 1 OF 1 |
| SURFACE QUALITY | 80-50 | 80-50 | | | | | |
| BEVEL | PROTECTIVE AS NEEDED | PROTECTIVE AS NEEDED | | | | | |