

NOTES:

1. SUBSTRATE:
HOYA GLASS: ND-50
2. SURFACE S2 TO BE PARALLEL WITH SURFACE S1 TO WITHIN <0.02 mm

**FOR INFORMATION ONLY:
DO NOT MANUFACTURE
PARTS TO THIS DRAWING**

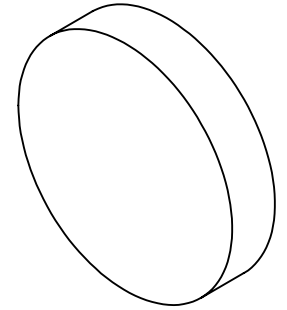

3. FINE GRIND SURFACE

4. COATING SPECIFICATION:
S1 & S2:R(ABS) ≤1.5% @ 750 - 800nm
R(ABS) ≤1.0% @ 800 - 1550nm
R(AVG) ≤0.7% @ 750 - 1550nm

5. OPTICAL DENSITY: 0.3 +/-0.05 @400-700nm

6. TRANSMISSION (%): 50.0% AVERAGE FROM 400-700nm

7. ROHS COMPLIANT

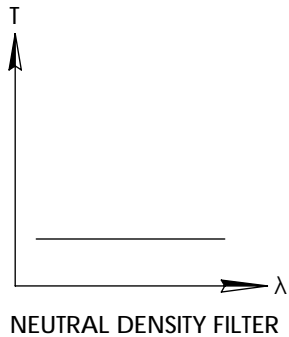
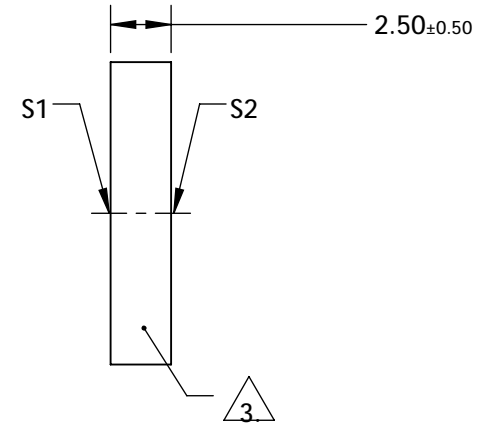
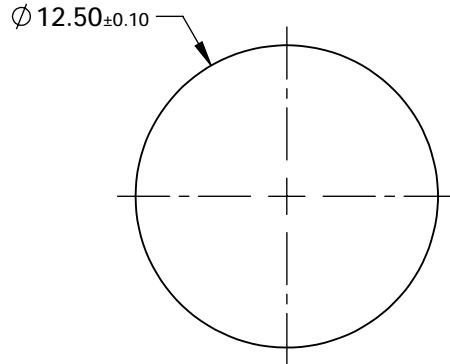

SPECIFICATIONS SUBJECT TO CHANGE WITHOUT NOTICE
DIMENSIONS ARE FOR REFERENCE ONLY

EO® Edmund Optics®

	S1	S2	THIRD ANGLE PROJECTION		TITLE	0.3 OD, 12.5mm DIA., NIR II COATED, ABSORPTIVE ND FILTER	
SHAPE	PLANO	PLANO	ALL DIMS IN	mm	DWG NO	13220	SHEET 1 OF 1
SURFACE QUALITY	80-50	80-50					
BEVEL	PROTECTIVE AS NEEDED	PROTECTIVE AS NEEDED					