

**FOR INFORMATION ONLY:
DO NOT MANUFACTURE
PARTS TO THIS DRAWING**

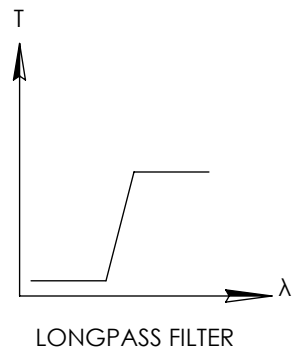
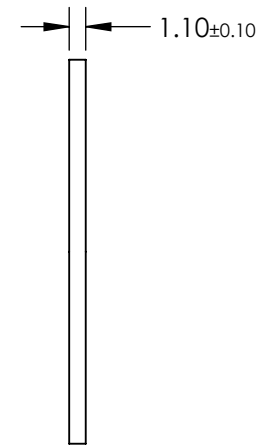
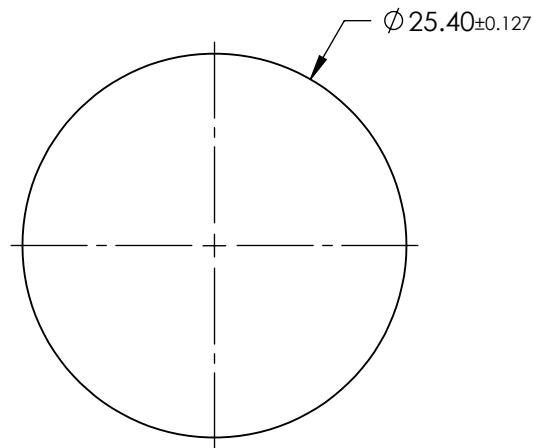

	VALUE
SHAPE	PLANO
CUT-ON WAVELENGTH (nm)	1000±9
TRANSMISSION WAVELENGTH (nm)	1035 - 2500
TRANSMISSION (%)	>90 (TYPICAL)
REJECTION WAVELENGTH (nm)	200 - 860
SURFACE QUALITY	80-50
CLEAR APERTURE (%)	90
DURABILITY, PHYSICAL	MIL-C-48497
DURABILITY, ENVIRONMENTAL	MIL-STD-810, METHOD 507.3, PRCEDURE III, MODIFIED TO 40 CYCLES
BEVEL MAX FACE	PROTECTIVE AS NEEDED

SPECIFICATIONS SUBJECT TO CHANGE WITHOUT NOTICE
DIMENSIONS ARE FOR REFERENCE ONLY

EO® Edmund Optics®



TITLE	1000nm, 25.4mm DIA., COLORED GLASS REPLACEMENT LONGPASS FILTER		
DWG NO	15463	SHEET	1 OF 1

ALL DIMS IN

mm