

NOTES:

1. MATERIAL: BLACK ANODIZED ALUMINUM
2. RoHS: COMPLIANT

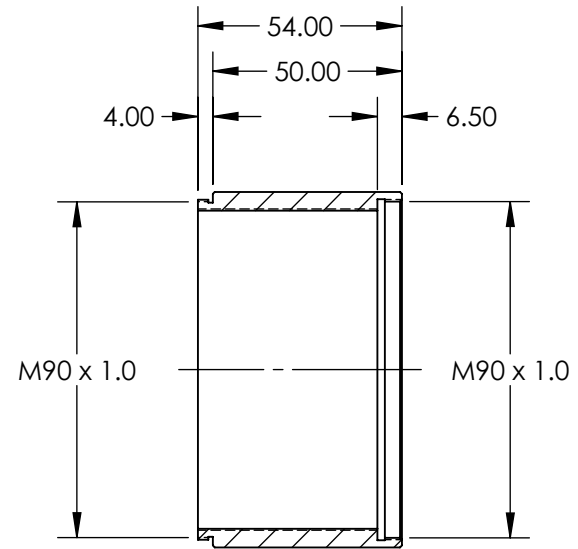
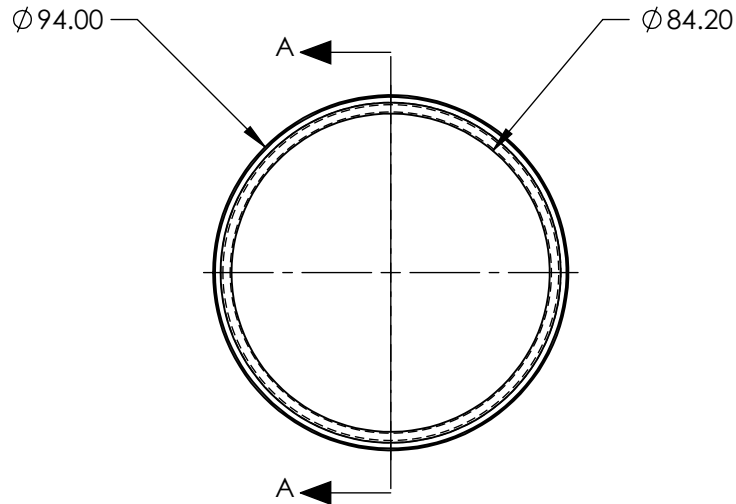

SECTION A-A

SPECIFICATIONS SUBJECT TO CHANGE WITHOUT NOTICE
DIMENSIONS ARE FOR REFERENCE ONLY

**FOR INFORMATION ONLY:
DO NOT MANUFACTURE
PARTS TO THIS DRAWING**

EO[®] Edmund Optics[®]

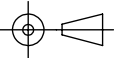
THIRD ANGLE PROJECTION 		TITLE	50mm M90 x 1mm EXTENSION TUBE	
ALL DIMS IN	mm	DWG NO	13964	SHEET 1 OF 1