

NOTES:

1. SUBSTRATE:
SCHOTT NG4
2. SURFACE S2 TO BE PARALLEL WITH SURFACE S1 TO WITHIN < 3 ARCMIN
3. OPTICAL DENSITY: 1.58
4. TRANSMISSION (%): 2.6% AVERAGE AT 550nm

FOR INFORMATION ONLY:
DO NOT MANUFACTURE
PARTS TO THIS DRAWING

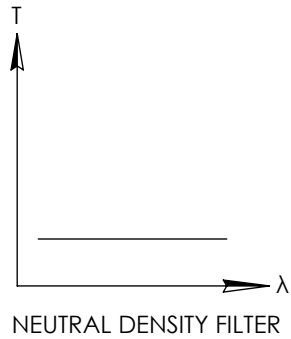
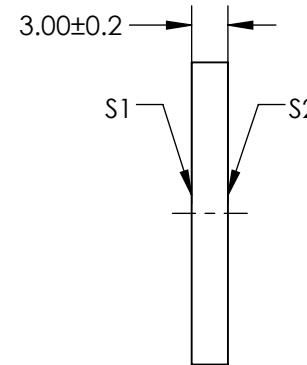
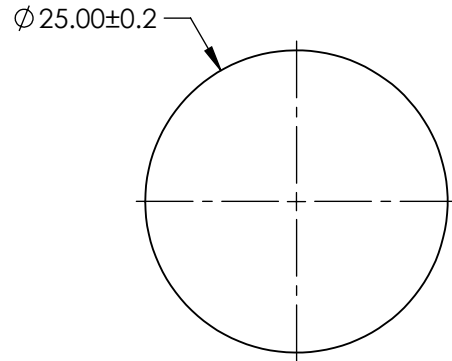
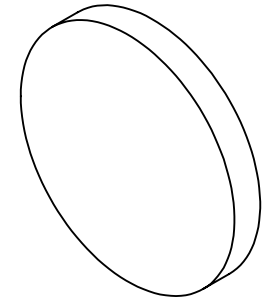

SPECIFICATIONS SUBJECT TO CHANGE WITHOUT NOTICE
DIMENSIONS ARE FOR REFERENCE ONLY

EO® **Edmund Optics**®

	S1	S2	THIRD ANGLE PROJECTION		TITLE	SCHOTT Absorptive ND Filter NG4, 3mm Thick, 25mm Dia	
SHAPE	PLANO	PLANO	ALL DIMS IN	mm	DWG NO	14091	SHEET 1 OF 1
SURFACE QUALITY	60-40	60-40					
BEVEL	PROTECTIVE AS NEEDED	PROTECTIVE AS NEEDED					