

NOTES:

1. SUBSTRATE:
N-BK7
2. ROHS COMPLIANT
3. COATING (APPLY ACROSS COATING APERTURE)
S1 & S2: MgF2 (400-700nm)
R(AVG) ≤ 1.75% @ 400 - 700nm
4. FOCAL LENGTH (EFL): 24.00 ± 1 %
FOCAL LENGTH (BFL) FROM MECHANICAL HOUSING: 21.15
5. LENS INCLUDED: #31-855
MOUNT INCLUDED: #54-615

**FOR INFORMATION ONLY:
DO NOT MANUFACTURE
PARTS TO THIS DRAWING**

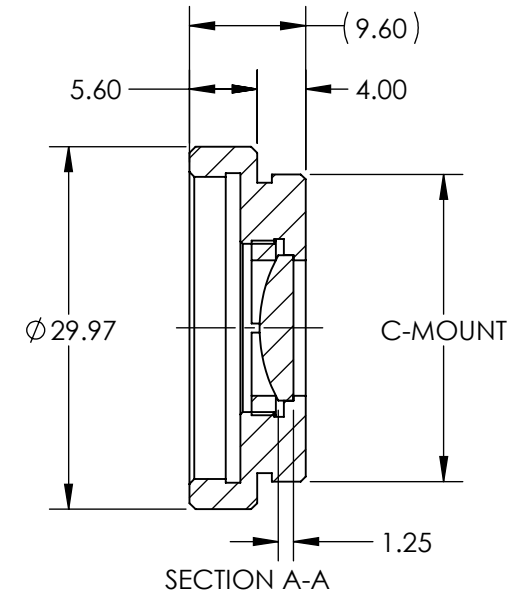
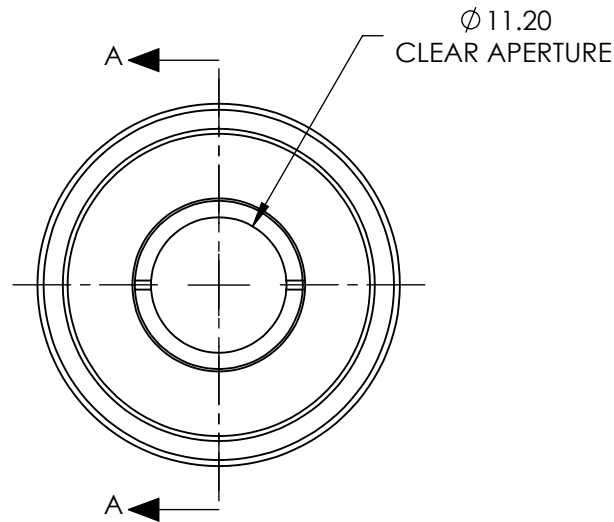

SPECIFICATIONS SUBJECT TO CHANGE WITHOUT NOTICE
DIMENSIONS ARE FOR REFERENCE ONLY

	S1	S2
SHAPE	CONVEX	PLANO
RADIUS	12.42	INFINITY
SURFACE QUALITY	40-20	40-20
POWER AT 632.8nm	1.5λ	1.5λ
IRREGULARITY AT 632.8nm	λ/4	λ/4

THIRD ANGLE PROJECTION

ALL DIMS IN mm

EO® **Edmund Optics**®

TITLE

11.2mm CA, 24mm FL, Mounted MgF2
Coated Plano-Convex Lens

DWG NO

12917

SHEET
1 OF 1