

NOTES:

1. MATERIAL: BLACK ANODIZED ALUMINUM
2. RoHS: COMPLIANT

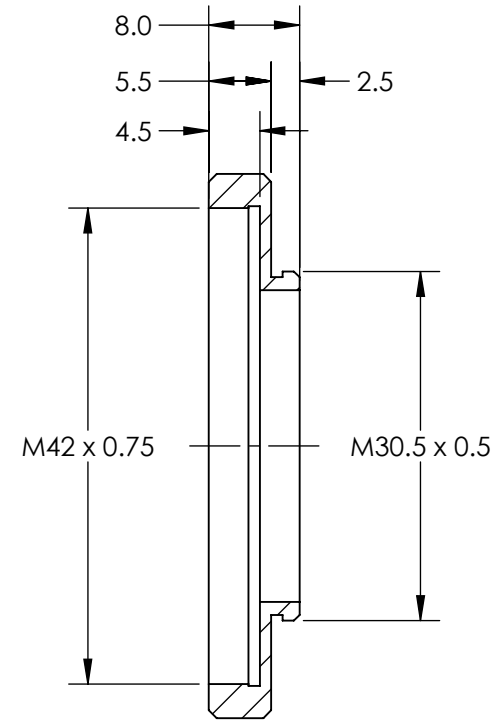
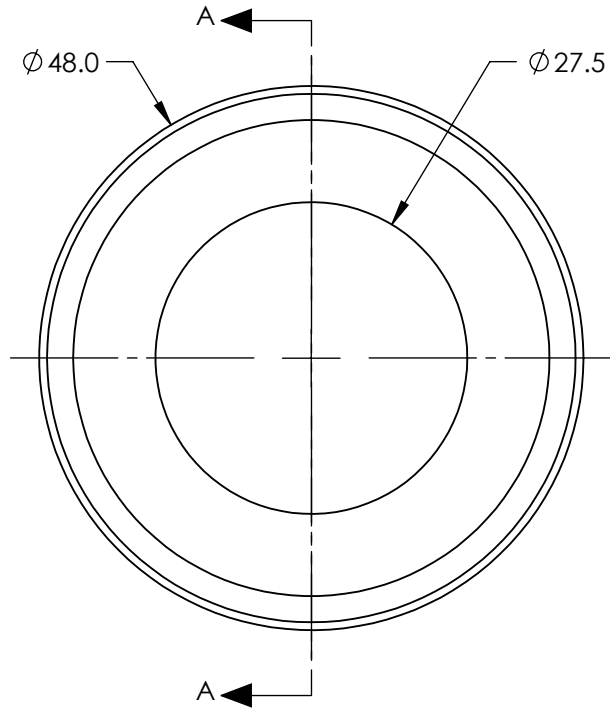

SECTION A-A

SPECIFICATIONS SUBJECT TO CHANGE WITHOUT NOTICE
 DIMENSIONS ARE FOR REFERENCE ONLY

**FOR INFORMATION ONLY:
 DO NOT MANUFACTURE
 PARTS TO THIS DRAWING**

EO[®] Edmund Optics[®]

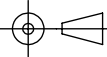
THIRD ANGLE PROJECTION 		TITLE	M30.5 x 0.5 TO T-MOUNT STEP-UP ADAPTER	
ALL DIMS IN	mm	DWG NO	12482	SHEET 1 OF 1