

NOTES:

1. MATERIAL:
HOUSING: STAINLESS STEEL
LENS: D-ZLcF52LA
2. COATING (APPLY ACROSS CLEAR APERTURE)
R(AVG) <0.4% @ 1050 - 1600nm
3. CLEAR APERTURE: 4.95 mm
4. RoHS: COMPLIANT

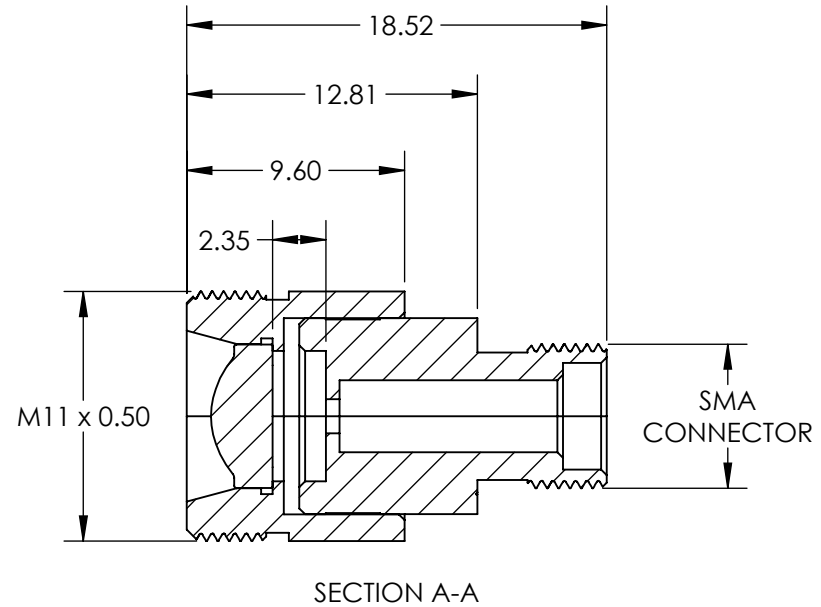

SPECIFICATIONS SUBJECT TO CHANGE WITHOUT NOTICE
DIMENSIONS ARE FOR REFERENCE ONLY

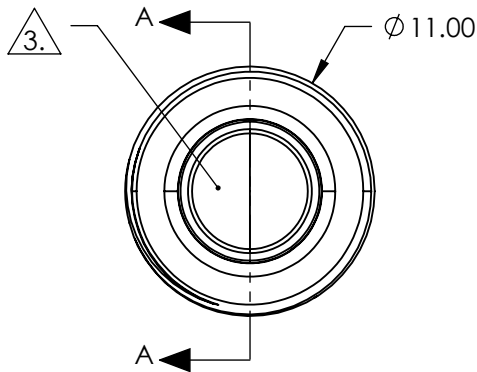
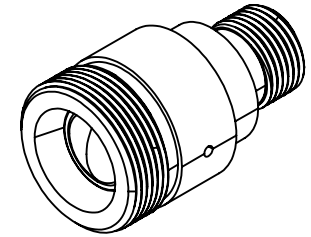

**FOR INFORMATION ONLY:
DO NOT MANUFACTURE
PARTS TO THIS DRAWING**

THIRD ANGLE PROJECTION		TITLE	1550nm Alignment, 0.55 NA Fiber Collimator w/ SMA Connector	
ALL DIMS IN	mm	DWG NO	83733	SHEET 1 OF 1