

FOCAL LENGTH (EFL): $17,5 \pm 0,18$
 BACK FOCAL LENGTH (BFL): $15,46$

1 BLACKENED SURFACE

SURFACE A	SURFACE B	SURFACE C
$\varnothing e 5,625$	$\varnothing e 5,625$	$\varnothing e 5,625$
CEMENT: NOA 61 OR EQUIVALENT		

PROTECTIVE CHAMFERS AS NEEDED		FIRST ANGLE PROJECTION	 Edmund Optics[®]	
ROHS: COMPLIANT	SCALE: NONE $\lambda = 587,6nm$			
SPECIFICATIONS SUBJECT TO CHANGE WITHOUT NOTICE. DIMENSIONS ARE FOR REFERENCE ONLY			TITLE	6,25mm Dia, x 17,5mm FL, VIS 0, Inked, Achromatic Lens
FOR INFORMATION ONLY: DO NOT MANUFACTURE PARTS TO THIS DRAWING			ALL DIMS IN:	mm
INDICATIONS IN ACCORDANCE WITH ISO 10110				499371NK
			SHEET SIZE	A4
			SHEET	1 OF 3

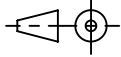
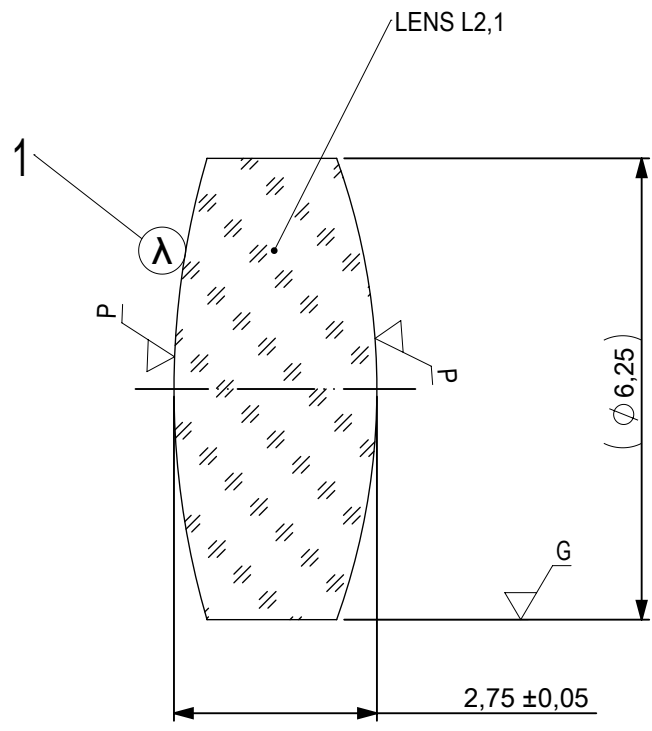

1 AR COATING: VIS 0°
R(AVG) ≤ 0,4% FROM 425-675nm @ 0° AOI

LEFT SURFACE	MATERIAL	RIGHT SURFACE
R 11,125±0,011 CX	GLASS N-SSK8 618/498	R 9,22±0,009 CX
Øe 5,625		Øe 5,625
3/ 3 (0,5) λ=632,8 nm		3/ 3 (0,5) λ=632,8 nm
4/ -		4/ -
5/ 40 - 20 (MIL-PRF-13830B)		5/ 40 - 20 (MIL-PRF-13830B)
6/ -		6/ -

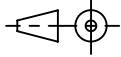
PROTECTIVE CHAMFERS AS NEEDED		FIRST ANGLE PROJECTION			
ROHS: COMPLIANT	SCALE: NONE λ = 587,6nm				
SPECIFICATIONS SUBJECT TO CHANGE WITHOUT NOTICE. DIMENSIONS ARE FOR REFERENCE ONLY			TITLE	6,25mm Dia, x 17,5mm FL, VIS 0, Inked, Achromatic Lens	
FOR INFORMATION ONLY: DO NOT MANUFACTURE PARTS TO THIS DRAWING			ALL DIMS IN: mm	DWG NO	499371NK
INDICATIONS IN ACCORDANCE WITH ISO 10110					SHEET 2 OF 3

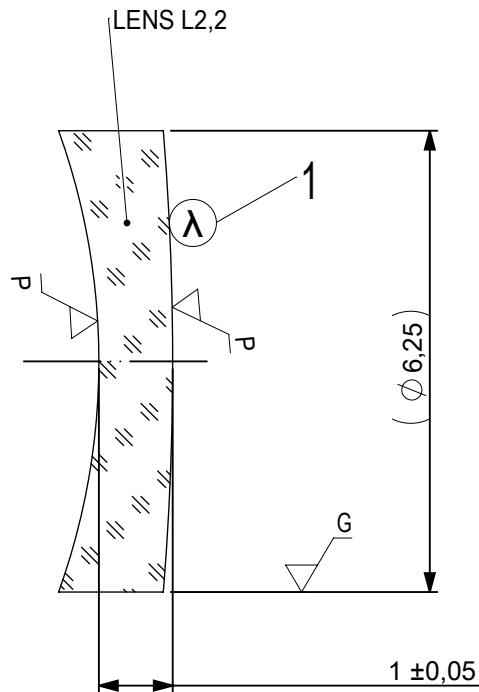

1 AR COATING: VIS 0°
R(AVG) ≤ 0,4% FROM 425-675nm @ 0° AOI

LEFT SURFACE	MATERIAL	RIGHT SURFACE
R 9,22±0,009 CV Øe 5,625 3/ 3 (0,5) λ=632,8 nm 4/ - 5/ 40 - 20 (MIL-PRF-13830B) 6/ -	GLASS N-SF56 785/261	R 38,49±0,038 CX Øe 5,625 3/ 3 (0,5) λ=632,8 nm 4/ - 5/ 40 - 20 (MIL-PRF-13830B) 6/ -

PROTECTIVE CHAMFERS AS NEEDED

ROHS: COMPLIANT
SCALE: NONE λ = 587,6nm

SPECIFICATIONS SUBJECT TO CHANGE WITHOUT NOTICE. DIMENSIONS ARE FOR REFERENCE ONLY

FOR INFORMATION ONLY: DO NOT MANUFACTURE PARTS TO THIS DRAWING

INDICATIONS IN ACCORDANCE WITH ISO 10110

FIRST ANGLE PROJECTION

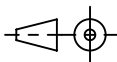

ALL DIMS IN: mm

EO® Edmund Optics®

TITLE 6,25mm Dia, x 17,5mm FL, VIS 0, Inked, Achromatic Lens

DWG NO 499371NK

SHEET SIZE A4 SHEET 3 OF 3