

FOCAL LENGTH (EFL):  $250 \pm 2,5$   
 BACK FOCAL LENGTH (BFL):  $244,32$

SURFACE A	SURFACE B	SURFACE C
$\varnothing e 39$	$\varnothing e 39$	$\varnothing e 39$
CEMENT: NOA 61 OR EQUIVALENT		

PROTECTIVE CHAMFERS AS NEEDED		FIRST ANGLE PROJECTION			
ROHS: COMPLIANT	SCALE: NONE $\lambda = 587,6\text{nm}$				
SPECIFICATIONS SUBJECT TO CHANGE WITHOUT NOTICE. DIMENSIONS ARE FOR REFERENCE ONLY			TITLE	40mm Dia, x 250mm FL, VIS-NIR Coated, Achromatic Lens	
FOR INFORMATION ONLY: DO NOT MANUFACTURE PARTS TO THIS DRAWING			ALL DIMS IN:	mm	DWG NO
INDICATIONS IN ACCORDANCE WITH ISO 10110				SHEET SIZE	A4
					SHEET 1 OF 3

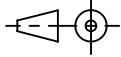
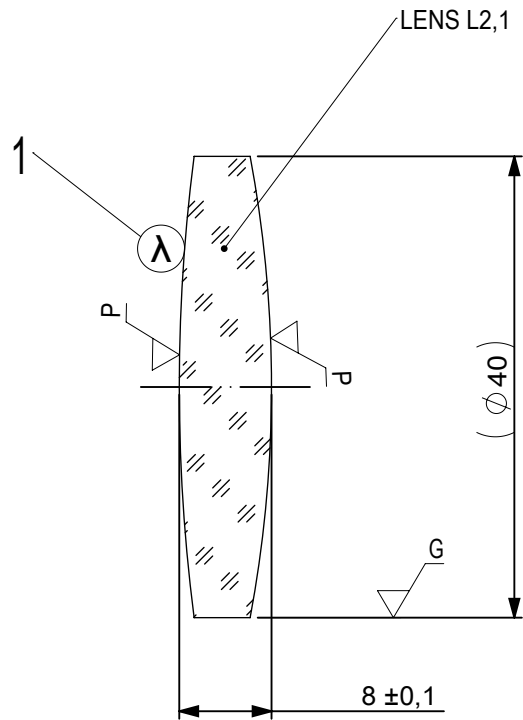

- 1 AR COATING: VIS-NIR  
 R(ABS) ≤ 0,25% AT 880nm @ 0° AOI  
 R(AVG) ≤ 1,25% FROM 400-870nm @ 0° AOI  
 R(AVG) ≤ 1,25% FROM 890-1000nm @ 0° AOI

LEFT SURFACE	MATERIAL	RIGHT SURFACE
R 156±0,156 CX Øe 39 3/ 3 (0,5) λ=632,8 nm 4/ - 5/ 40 - 20 (MIL-PRF-13830B) 6/ -	GLASS N-BK7 517/642	R 108,7±0,109 CX Øe 39 3/ 3 (0,5) λ=632,8 nm 4/ - 5/ 40 - 20 (MIL-PRF-13830B) 6/ -

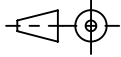
PROTECTIVE CHAMFERS AS NEEDED		FIRST ANGLE PROJECTION	 <b>Edmund Optics®</b>	
ROHS: COMPLIANT	SCALE: NONE λ = 587,6nm			
SPECIFICATIONS SUBJECT TO CHANGE WITHOUT NOTICE. DIMENSIONS ARE FOR REFERENCE ONLY			TITLE	40mm Dia, x 250mm FL, VIS-NIR Coated, Achromatic Lens
FOR INFORMATION ONLY: DO NOT MANUFACTURE PARTS TO THIS DRAWING			ALL DIMS IN: mm	DWG NO
INDICATIONS IN ACCORDANCE WITH ISO 10110			SHEET SIZE	A4
				SHEET 2 OF 3

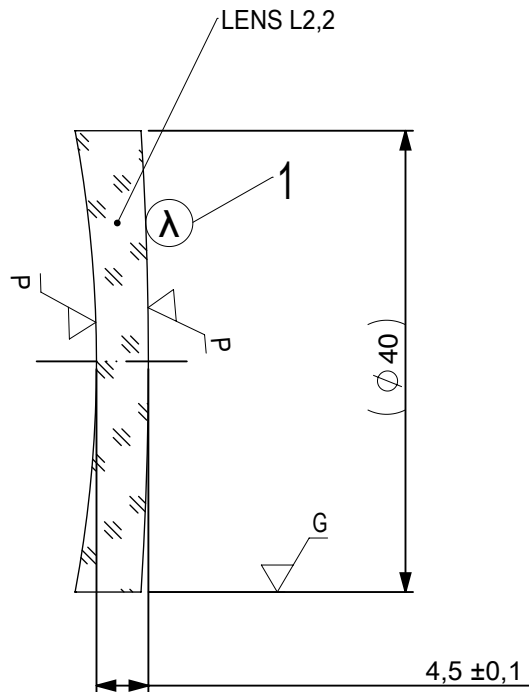

- 1 AR COATING: VIS-NIR  
 R(ABS) ≤ 0,25% AT 880nm @ 0° AOI  
 R(AVG) ≤ 1,25% FROM 400-870nm @ 0° AOI  
 R(AVG) ≤ 1,25% FROM 890-1000nm @ 0° AOI

LEFT SURFACE	MATERIAL	RIGHT SURFACE
R 108,7±0,109 CV	GLASS N-SF5 673/322	R 313,64±0,314 CX
Øe 39		Øe 39
3/ 3 (0,5) λ=632,8 nm		3/ 3 (0,5) λ=632,8 nm
4/ -		4/ -
5/ 40 - 20 (MIL-PRF-13830B)		5/ 40 - 20 (MIL-PRF-13830B)
6/ -		6/ -

PROTECTIVE CHAMFERS AS NEEDED

ROHS: COMPLIANT      SCALE: NONE      λ = 587,6nm

SPECIFICATIONS SUBJECT TO CHANGE WITHOUT NOTICE. DIMENSIONS ARE FOR REFERENCE ONLY

FOR INFORMATION ONLY: DO NOT MANUFACTURE PARTS TO THIS DRAWING

INDICATIONS IN ACCORDANCE WITH ISO 10110

FIRST ANGLE PROJECTION

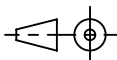

ALL DIMS IN: mm



Edmund Optics®

TITLE 40mm Dia, x 250mm FL, VIS-NIR Coated, Achromatic Lens

DWG NO 49384

SHEET SIZE A4

SHEET 3 OF 3