

FOCAL LENGTH (EFL): $60 \pm 0,6$
 BACK FOCAL LENGTH (BFL): $58,46$

1 BLACKENED SURFACE

SURFACE A	SURFACE B	SURFACE C
$\varnothing_e 5,625$	$\varnothing_e 5,625$	$\varnothing_e 5,625$
CEMENT: NOA 61 OR EQUIVALENT		

PROTECTIVE CHAMFERS AS NEEDED		FIRST ANGLE PROJECTION	 Edmund Optics[®]		
ROHS: COMPLIANT	SCALE: NONE $\lambda = 587,6\text{nm}$				
SPECIFICATIONS SUBJECT TO CHANGE WITHOUT NOTICE. DIMENSIONS ARE FOR REFERENCE ONLY			TITLE	6,25mm Dia, x 60mm FL, VIS-NIR, Inked, Achromatic Lens	
FOR INFORMATION ONLY: DO NOT MANUFACTURE PARTS TO THIS DRAWING			ALL DIMS IN:	DWG NO	49312INK
INDICATIONS IN ACCORDANCE WITH ISO 10110		mm			SHEET 1 OF 3

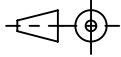
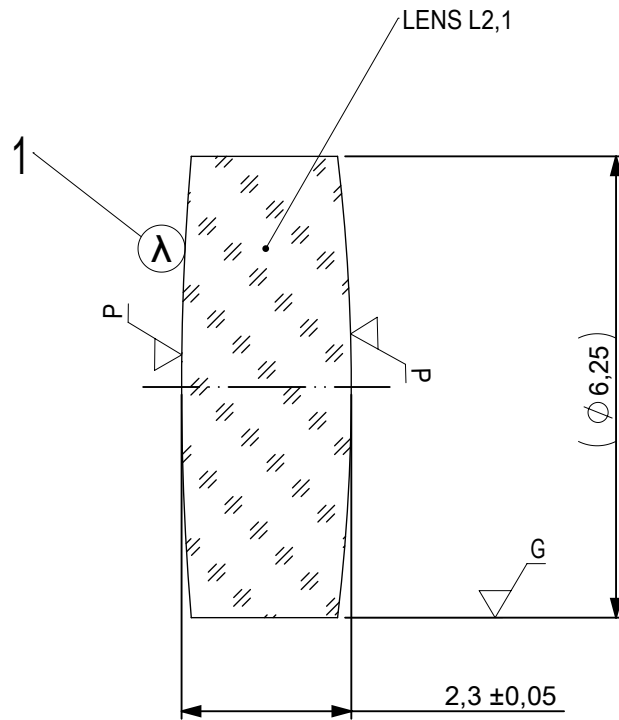

- 1 AR COATING: VIS-NIR
 R(ABS) ≤ 0,25% AT 880nm @ 0° AOI
 R(AVG) ≤ 1,25% FROM 400-870nm @ 0° AOI
 R(AVG) ≤ 1,25% FROM 890-1000nm @ 0° AOI

LEFT SURFACE	MATERIAL	RIGHT SURFACE
R 37,16±0,037 CX Øe 5,625 3/ 3 (0,5) λ=632,8 nm 4/ - 5/ 40 - 20 (MIL-PRF-13830B) 6/ -	GLASS N-BK7 517/642	R 26,28±0,026 CX Øe 5,625 3/ 3 (0,5) λ=632,8 nm 4/ - 5/ 40 - 20 (MIL-PRF-13830B) 6/ -

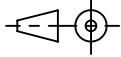
PROTECTIVE CHAMFERS AS NEEDED		FIRST ANGLE PROJECTION	 Edmund Optics®	
ROHS: COMPLIANT	SCALE: NONE λ = 587,6nm			
SPECIFICATIONS SUBJECT TO CHANGE WITHOUT NOTICE. DIMENSIONS ARE FOR REFERENCE ONLY			TITLE	6,25mm Dia, x 60mm FL, VIS-NIR, Inked, Achromatic Lens
FOR INFORMATION ONLY: DO NOT MANUFACTURE PARTS TO THIS DRAWING			ALL DIMS IN: mm	DWG NO
INDICATIONS IN ACCORDANCE WITH ISO 10110			SHEET SIZE	A4
				SHEET 2 OF 3

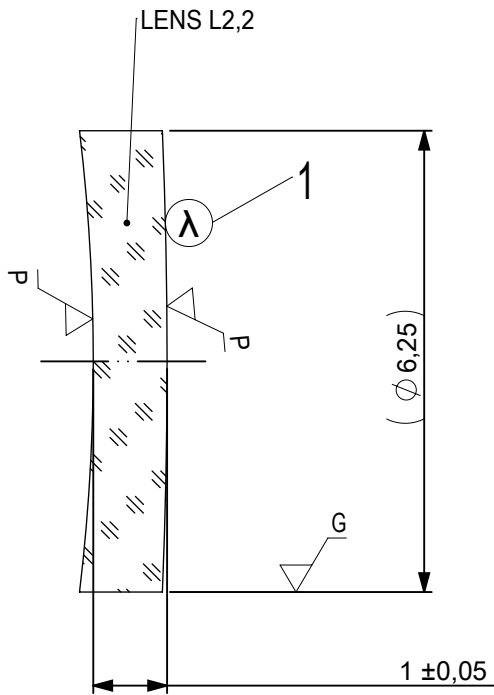

- 1 AR COATING: VIS-NIR
 R(ABS) ≤ 0,25% AT 880nm @ 0° AOI
 R(AVG) ≤ 1,25% FROM 400-870nm @ 0° AOI
 R(AVG) ≤ 1,25% FROM 890-1000nm @ 0° AOI

LEFT SURFACE	MATERIAL	RIGHT SURFACE
R 26,28±0,026 CV Øe 5,625 3/ 3 (0,5) λ=632,8 nm 4/ - 5/ 40 - 20 (MIL-PRF-13830B) 6/ -	GLASS N-SF5 673/322	R 76,48±0,076 CX Øe 5,625 3/ 3 (0,5) λ=632,8 nm 4/ - 5/ 40 - 20 (MIL-PRF-13830B) 6/ -

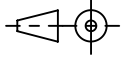
PROTECTIVE CHAMFERS AS NEEDED		FIRST ANGLE PROJECTION	 Edmund Optics®	
ROHS: COMPLIANT	SCALE: NONE λ = 587,6nm			
SPECIFICATIONS SUBJECT TO CHANGE WITHOUT NOTICE. DIMENSIONS ARE FOR REFERENCE ONLY			TITLE	6,25mm Dia, x 60mm FL, VIS-NIR, Inked, Achromatic Lens
FOR INFORMATION ONLY: DO NOT MANUFACTURE PARTS TO THIS DRAWING			ALL DIMS IN: mm	DWG NO
INDICATIONS IN ACCORDANCE WITH ISO 10110			SHEET SIZE	A4
			SHEET	3 OF 3