

FOCAL LENGTH (EFL):  $30 \pm 0,3$   
 BACK FOCAL LENGTH (BFL):  $27,22$

SURFACE A	SURFACE B	SURFACE C
$\varnothing e 5,4$	$\varnothing e 5,4$	$\varnothing e 5,4$
CEMENT: NOA 61 OR EQUIVALENT		

PROTECTIVE CHAMFERS AS NEEDED		FIRST ANGLE PROJECTION			
ROHS: COMPLIANT	SCALE: NONE $\lambda = 880\text{nm}$				
SPECIFICATIONS SUBJECT TO CHANGE WITHOUT NOTICE. DIMENSIONS ARE FOR REFERENCE ONLY			TITLE	6mm Dia, x 30mm FL, NIR II Coated, Achromatic Lens	
FOR INFORMATION ONLY: DO NOT MANUFACTURE PARTS TO THIS DRAWING			ALL DIMS IN:	DWG NO	45788
INDICATIONS IN ACCORDANCE WITH ISO 10110		mm			SHEET 1 OF 3

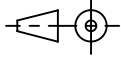
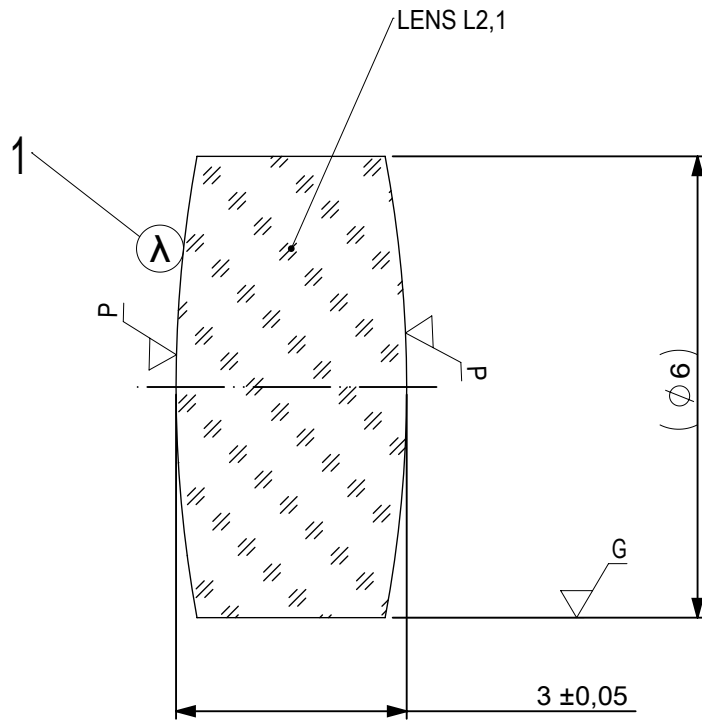

- 1 AR COATING: NIR II  
 R(ABS) ≤ 1,5% FROM 750-800nm @ 0° AOI  
 R(ABS) ≤ 1,0% FROM 800-1550nm @ 0° AOI  
 R(AVG) ≤ 0,7% FROM 750-1550nm @ 0° AOI

LEFT SURFACE	MATERIAL	RIGHT SURFACE
R 16,66±0,017 CX Øe 5,4 3/ 3 (0,5) λ=632,8 nm 4/ - 5/ 40 - 20 (MIL-PRF-13830B) 6/ -	GLASS N-LaK22 651/559	R 16,18±0,016 CX Øe 5,4 3/ 3 (0,5) λ=632,8 nm 4/ - 5/ 40 - 20 (MIL-PRF-13830B) 6/ -

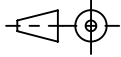
PROTECTIVE CHAMFERS AS NEEDED		FIRST ANGLE PROJECTION	 <b>Edmund Optics®</b>		
ROHS: COMPLIANT	SCALE: NONE λ = 880nm				
SPECIFICATIONS SUBJECT TO CHANGE WITHOUT NOTICE. DIMENSIONS ARE FOR REFERENCE ONLY			TITLE	6mm Dia, x 30mm FL, NIR II Coated, Achromatic Lens	
FOR INFORMATION ONLY: DO NOT MANUFACTURE PARTS TO THIS DRAWING			ALL DIMS IN:	mm	DWG NO
INDICATIONS IN ACCORDANCE WITH ISO 10110				SHEET SIZE	A4
					SHEET 2 OF 3

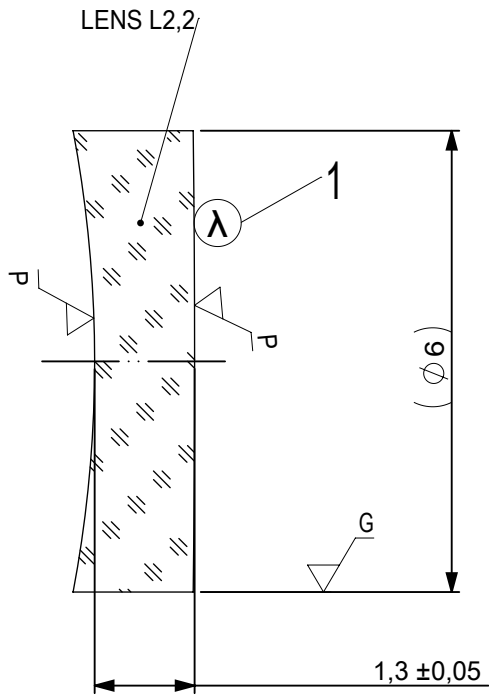

- 1 AR COATING: NIR II  
 R(ABS) ≤ 1,5% FROM 750-800nm @ 0° AOI  
 R(ABS) ≤ 1,0% FROM 800-1550nm @ 0° AOI  
 R(AVG) ≤ 0,7% FROM 750-1550nm @ 0° AOI

LEFT SURFACE	MATERIAL	RIGHT SURFACE
R 16,18±0,016 CV Øe 5,4 3/ 3 (0,5) λ=632,8 nm 4/ - 5/ 40 - 20 (MIL-PRF-13830B) 6/ -	GLASS N-SF6 805/254	R 246,07±0,246 CX Øe 5,4 3/ 3 (0,5) λ=632,8 nm 4/ - 5/ 40 - 20 (MIL-PRF-13830B) 6/ -

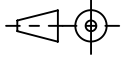
PROTECTIVE CHAMFERS AS NEEDED		FIRST ANGLE PROJECTION	 <b>Edmund Optics®</b>		
ROHS: COMPLIANT	SCALE: NONE λ = 880nm				
SPECIFICATIONS SUBJECT TO CHANGE WITHOUT NOTICE. DIMENSIONS ARE FOR REFERENCE ONLY			TITLE	6mm Dia, x 30mm FL, NIR II Coated, Achromatic Lens	
FOR INFORMATION ONLY: DO NOT MANUFACTURE PARTS TO THIS DRAWING			ALL DIMS IN:	mm	DWG NO
INDICATIONS IN ACCORDANCE WITH ISO 10110				SHEET SIZE	A4
				SHEET	3 OF 3