

NOTES:

1. MATERIAL: STAINLESS STEEL AND BLACK ANODIZED ALUMINUM
2. MAX TRAVEL DISTANCE: .5in
3. RoHS: EXEMPT

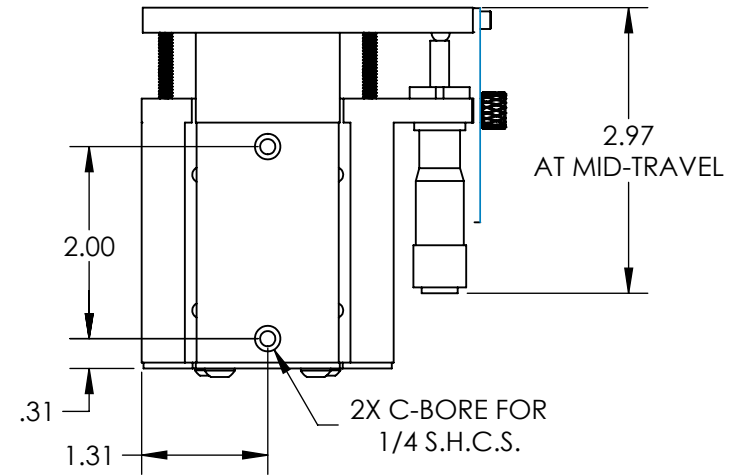
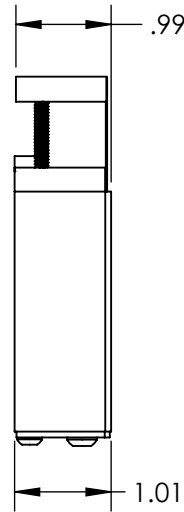
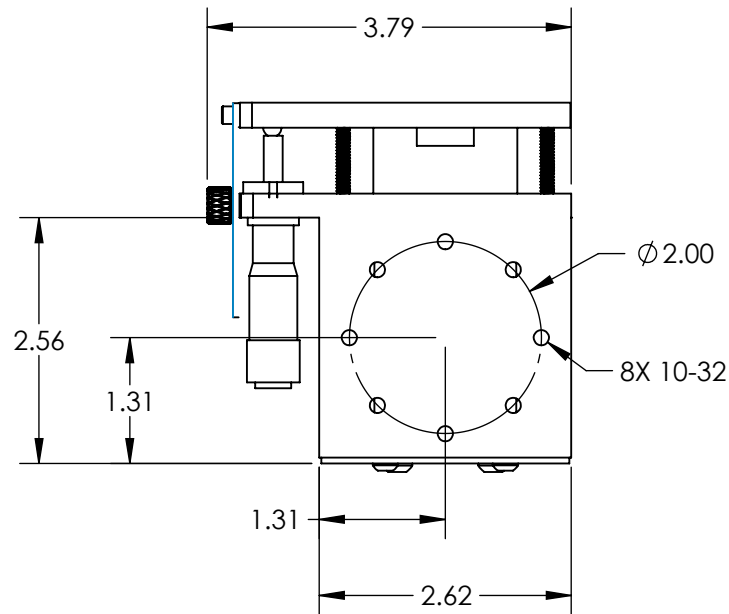

SPECIFICATIONS SUBJECT TO CHANGE WITHOUT NOTICE
DIMENSIONS ARE FOR REFERENCE ONLY

**FOR INFORMATION ONLY:
DO NOT MANUFACTURE
PARTS TO THIS DRAWING**

EO® Edmund Optics®

THIRD ANGLE PROJECTION		TITLE	0.5" TRAVEL, ENG MICROMETER, SOLID-TOP BALL BEARING STAGE	
ALL DIMS IN	in	DWG NO	38994	SHEET 1 OF 1