

**FOR INFORMATION ONLY:
DO NOT MANUFACTURE
PARTS TO THIS DRAWING**

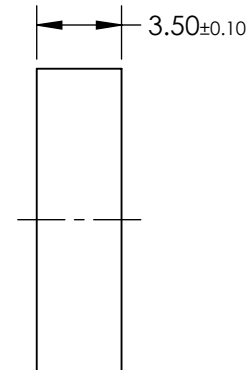
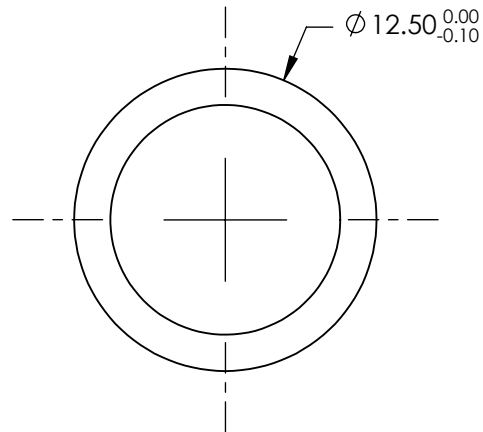
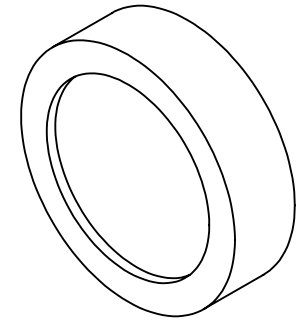

CENTER WAVELENGTH CWL (nm)	473
BANDWIDTH (nm)	1.8
OPTICAL DENSITY OD	≥ 6.0
TRANSMISSION (%)	> 90
SURFACE QUALITY	60-40
ANGLE OF INCIDENCE (°)	0 ± 2
DURABILITY (ENVIRONMENTAL)	MIL-STD-810F Paragraphs 501.4, 502.4, AND 507.4
DURABILITY (PHYSICAL)	MIL-C-48497A Paragraphs 4.5.3.1, 4.5.3.2, 4.5.3.3, 4.5.4.2, AND 4.5.5.3
OD 5 BLOCKING WAVELENGTH RANGE (nm)	404.2-468.3 & 477.7-600.9
OD 6 BLOCKING WAVELENGTH RANGE (nm)	435.2-465.9 & 480.1-520.3
RoHS	COMPLIANT

SPECIFICATIONS SUBJECT TO CHANGE WITHOUT NOTICE
DIMENSIONS ARE FOR REFERENCE ONLY

EO® **Edmund Optics**®

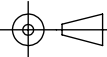
THIRD ANGLE PROJECTION 	TITLE	473nm High Performance Laser Line Filter 12.5mm Dia.	
	ALL DIMS IN	mm	DWG NO 12270
			SHEET 1 OF 1