

NOTES:

1. MATERIAL: BLACK MATTE ANODIZED ALUMINUM
2. RoHS: COMPLIANT

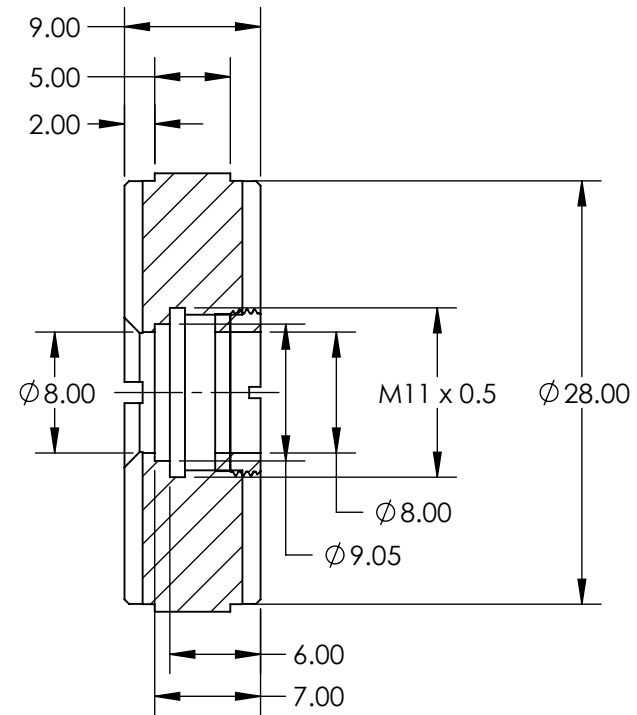
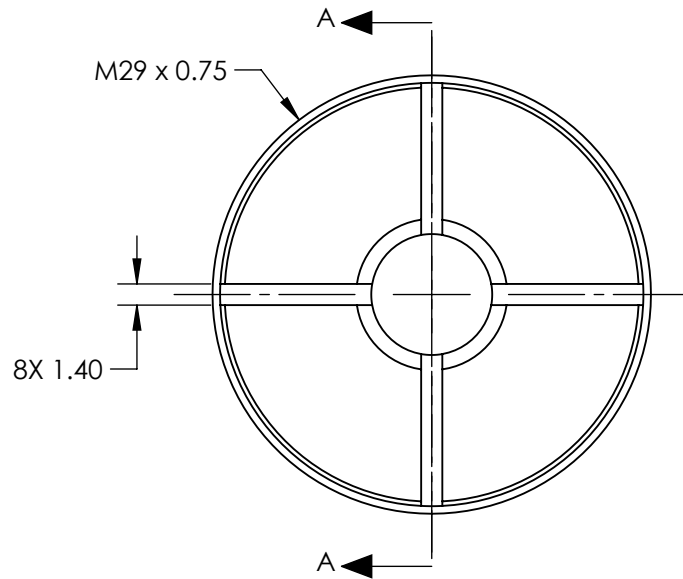
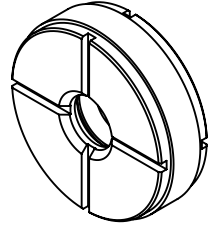

SECTION A-A

SPECIFICATIONS SUBJECT TO CHANGE WITHOUT NOTICE
DIMENSIONS ARE FOR REFERENCE ONLY

**FOR INFORMATION ONLY:
DO NOT MANUFACTURE
PARTS TO THIS DRAWING**

EO® Edmund Optics®

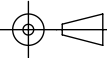
THIRD ANGLE PROJECTION 		TITLE	M29 TUBE 9S	
ALL DIMS IN	mm	DWG NO	38747	SHEET 1 OF 1