

NOTES:

1. ROHS: COMPLIANT

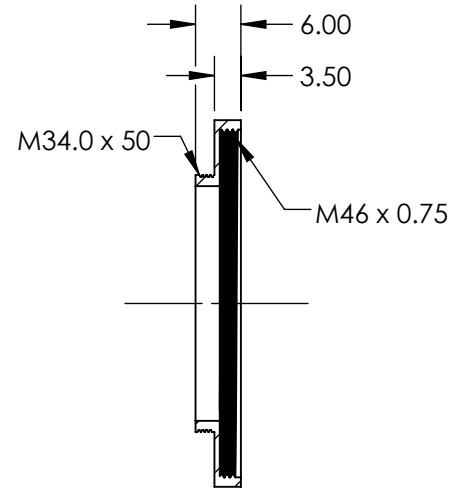
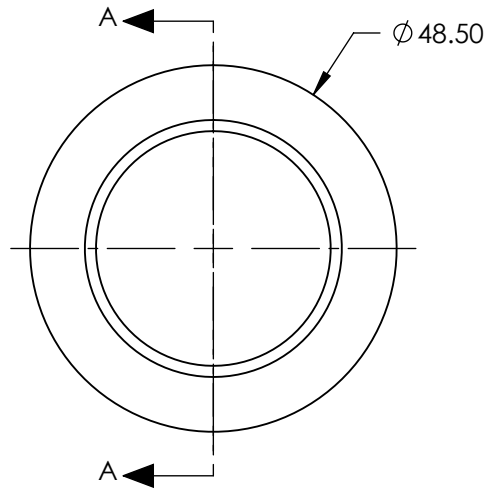
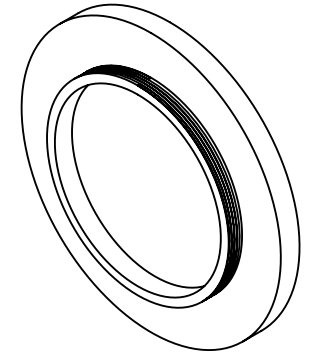

SECTION A-A

SPECIFICATIONS SUBJECT TO CHANGE WITHOUT NOTICE
DIMENSIONS ARE FOR REFERENCE ONLY

**FOR INFORMATION ONLY:
DO NOT MANUFACTURE
PARTS TO THIS DRAWING**

EO® Edmund Optics®

THIRD ANGLE PROJECTION 	TITLE	Step Adapter to M34.0 x 0.50 Filter Thread	
ALL DIMS IN	mm	DWG NO	66932
			SHEET 1 OF 1