

NOTES:

1. CONSTRUCTION:
Anodized Aluminum Alloy, Burnished Spring Steel Leaves
2. NUMBER OF LEAVES: 18
3. OPERATING TEMPERATURE (°C): <250
4. ROHS: COMPLIANT

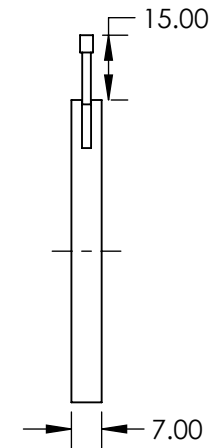
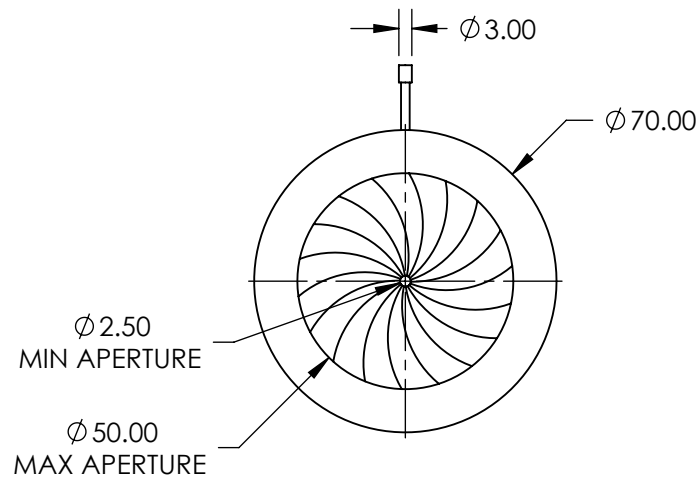

SPECIFICATIONS SUBJECT TO CHANGE WITHOUT NOTICE
DIMENSIONS ARE FOR REFERENCE ONLY

**FOR INFORMATION ONLY:
DO NOT MANUFACTURE
PARTS TO THIS DRAWING**

EO[®] Edmund Optics[®]

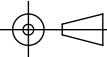
THIRD ANGLE PROJECTION 		TITLE	70mm Outer Dia., Burnished Steel Leaves Iris Diaphragm	
ALL DIMS IN	mm	DWG NO	57584	SHEET 1 OF 1