

NOTES:

1. CONSTRUCTION:
Anodized Aluminum Alloy, Anti-Reflection (AR) Leaves
2. NUMBER OF LEAVES: 8
3. OPERATING TEMPERATURE (°C): <180
4. ROHS: COMPLIANT

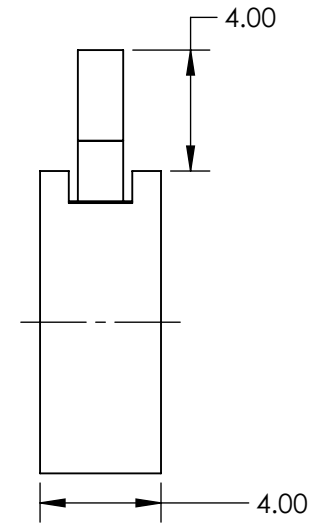
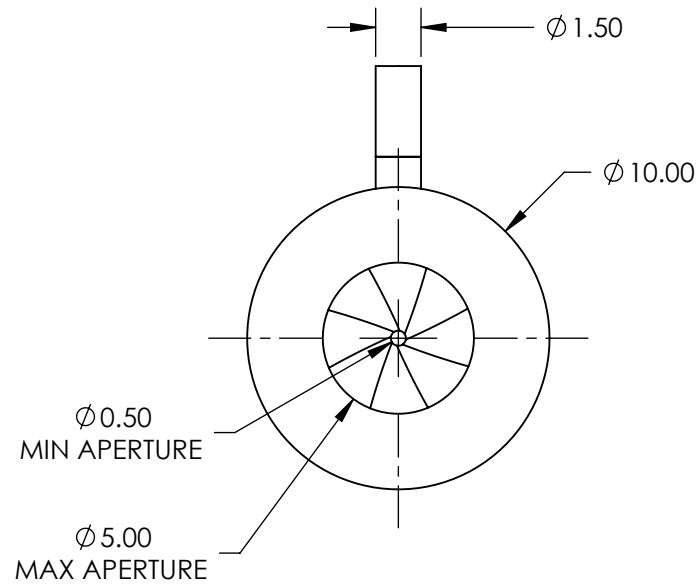

SPECIFICATIONS SUBJECT TO CHANGE WITHOUT NOTICE
DIMENSIONS ARE FOR REFERENCE ONLY

**FOR INFORMATION ONLY:
DO NOT MANUFACTURE
PARTS TO THIS DRAWING**

EO® Edmund Optics®

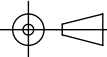
THIRD ANGLE PROJECTION 		TITLE	10mm Outer Dia., AR Steel Leaves Iris Diaphragm	
ALL DIMS IN	mm	DWG NO	57573	SHEET 1 OF 1