

NOTES:

1. CONSTRUCTION:  
Blackened Brass Housing, Black Spring Steel Leaves, Stainless Steel Pins
2. NUMBER OF LEAVES: Two Sets of 7
3. ROHS: COMPLIANT

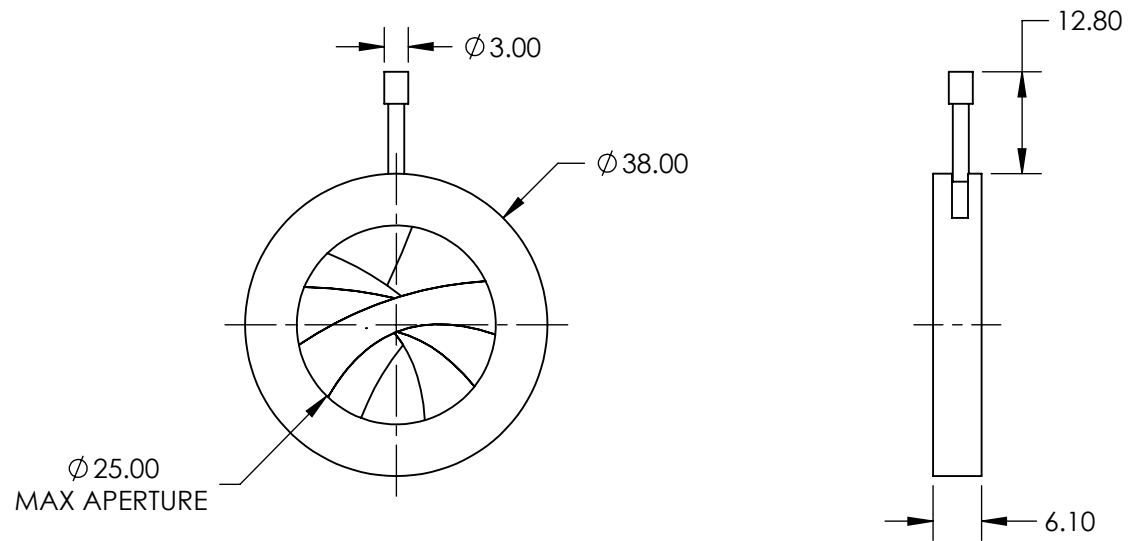

SPECIFICATIONS SUBJECT TO CHANGE WITHOUT NOTICE  
DIMENSIONS ARE FOR REFERENCE ONLY

**FOR INFORMATION ONLY:  
DO NOT MANUFACTURE  
PARTS TO THIS DRAWING**

**EO**® Edmund Optics®

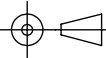
|  |    |        |  |                 |
|--|----|--------|--|-----------------|
| THIRD ANGLE PROJECTION  |    | TITLE  | Zero Aperture, 38mm Outer Diameter, Iris Diaphragm |                 |
| ALL DIMS IN  | mm | DWG NO | 53907  | SHEET<br>1 OF 1 |