

NOTES:

1. SUBSTRATE:
N-BK7
2. REFLECTION: 0.5%
DAMAGE THRESHOLD,
PULSED: Visible: 600 mJ/cm² @ 20ns, 1064nm: 4 J/cm² @ 20ns
CW: 500 W/cm²
3. BEAM DEVIATION: 1 arcmin
4. RETARDANCE: $\lambda/4 \pm \lambda/350$
5. DESIGN WAVELENGTH: 488nm
6. CONSTRUCTION: Birefringent Polymer Stack
7. OPERATING TEMPERATURE (°C): -20 to +50
8. ROHS: COMPLIANT
9. PRECISION POLYMER WAVEPLATES (RETARDERS) ARE MOUNTED IN A METAL RING WITH THE FAST AXIS CLEARLY MARKED

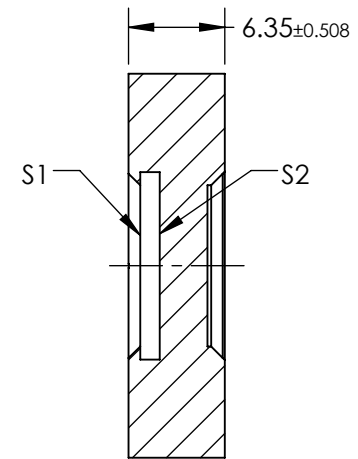
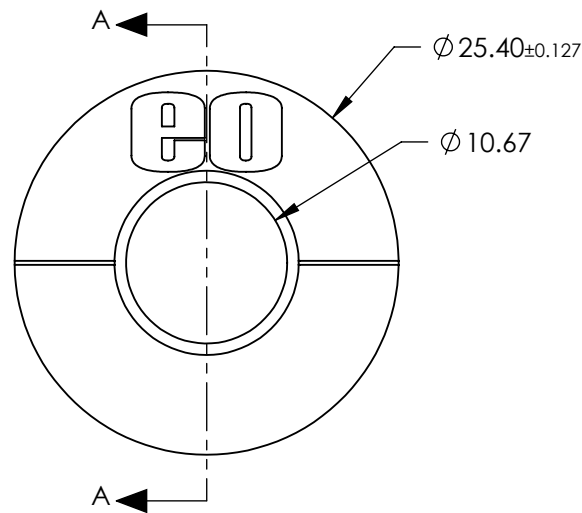
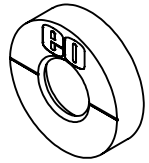

SECTION A-A

**FOR INFORMATION ONLY:
DO NOT MANUFACTURE
PARTS TO THIS DRAWING**

SPECIFICATIONS SUBJECT TO CHANGE WITHOUT NOTICE
DIMENSIONS ARE FOR REFERENCE ONLY

EO® Edmund Optics®

	S1	S2	THIRD ANGLE PROJECTION		TITLE	488nm, $\lambda/4$ Precision Zero Order Retarder	
CLEAR APERTURE	Ø10.16	Ø10.16	ALL DIMS IN	mm	DWG NO	49218	SHEET 1 OF 1
SURFACE QUALITY	40-20	40-20					