

NOTES:

- 1. MATERIAL: STAINLESS STEEL
- 2. RoHS: COMPLIANT

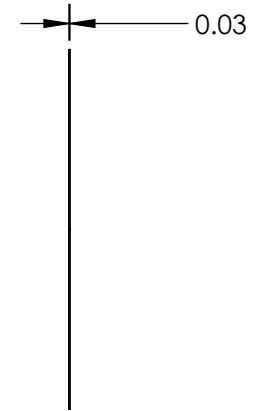
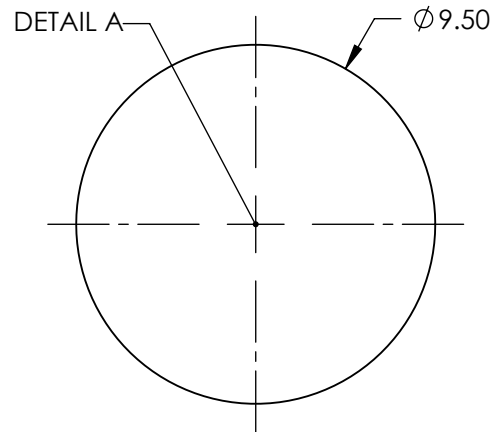
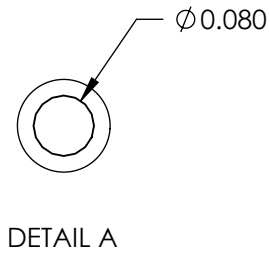
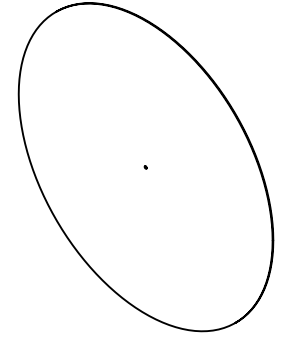

SPECIFICATIONS SUBJECT TO CHANGE WITHOUT NOTICE
DIMENSIONS ARE FOR REFERENCE ONLY

EO[®] Edmund Optics[®]

**FOR INFORMATION ONLY:
DO NOT MANUFACTURE
PARTS TO THIS DRAWING**

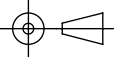
THIRD ANGLE PROJECTION 		TITLE	80μm APERTURE DIAMETER, UNMOUNTED, PRECISION PINHOLE	
ALL DIMS IN	mm	DWG NO	84063	SHEET 1 OF 1