

TECHSPEC® Scorpii™ Nd:YAG Beam Expanders 1064nm • 10X #37-069

TECHSPEC® Scorpii™ Nd:YAG Beam Expanders are designed for beam expansion applications such as laser engraving and material processing. These beam expanders feature AR coatings and are designed for the Nd:YAG laser wavelengths 355nm, 532nm, and 1064nm. The Scorpii beam expanders are available in multiple fixed magnifications from 2X to 10X with M22 x 0.75 threading. TECHSPEC® Scorpii™ Nd:YAG Beam Expanders are a cost-effective solution for system integration. Ideal for OEM quantities, these beam expanders can quickly meet prototyping and application timelines.

Design Wavelength:	1064nm
Expansion Power:	10X
Design Wavefront (P-V):	$\lambda/4$
Max Beam to Fill 85% of Output Aperture*:	2.3mm
Transmission @ DWL:	96%
Entrance Aperture:	3.5mm
Exit Aperture:	27mm
Housing Diameter¹:	29.95/39.95mm
Overall Length:	114mm
Weight:	164g
Mounting Thread:	M22 x 0.75
Substrate:	Optical Glass
Divergence Adjustment:	None

1. Housing expands to 39.95mm from 29.95mm

*Maximum beam diameter to utilize full clear aperture of the beam expander
Specifications subject to change

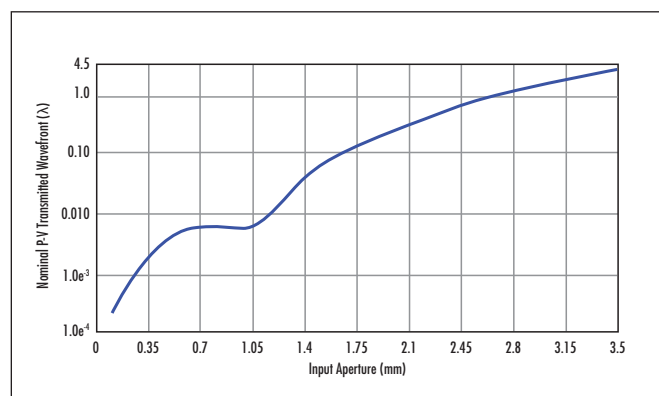
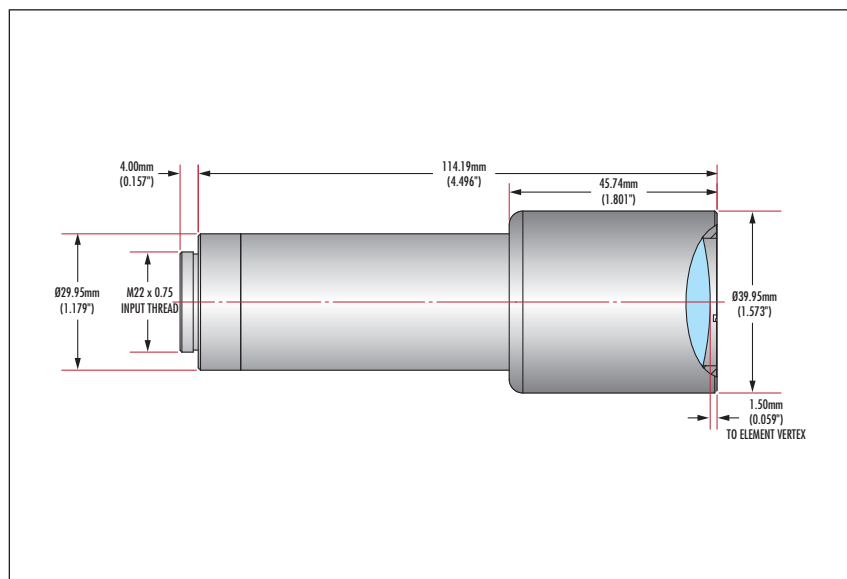

TECHSPEC® Scorpii™ Nd:YAG Beam Expanders are designed with diffraction-limited performance for a range of input beam diameters. These beam expanders are designed to increase the input beam diameter to a larger collimated beam. For custom wavelength and magnification combinations, please contact us.