

NOTES:

1. SUBSTRATE:
GRADE A FINE ANNEALED
SCHOTT: N-BK7 517/642
2. ROHS COMPLIANT
3. CENTERING TOLERANCE (AT 587.6nm):
BEAM DEVIATION (HALF ANGLE): <1 ARCMIN
4. COATING (APPLY ACROSS COATING APERTURE)
S1 & S2: NIR I
R(AVG) ≤ 0.5% FROM 600-1050nm @ 0° AOI
5. FINE GRIND SURFACE
6. POWER, IRREGULARITY, AND SURFACE QUALITY SPECIFICATIONS APPLY ACROSS CLEAR APERTURE
7. FOCAL LENGTH (EFL): 17.50mm ±1%
BACK FOCAL LENGTH (BFL): 15.66mm
8. PROTECTIVE BEVEL AS NEEDED
9. DESIGN WAVELENGTH: 587.6nm

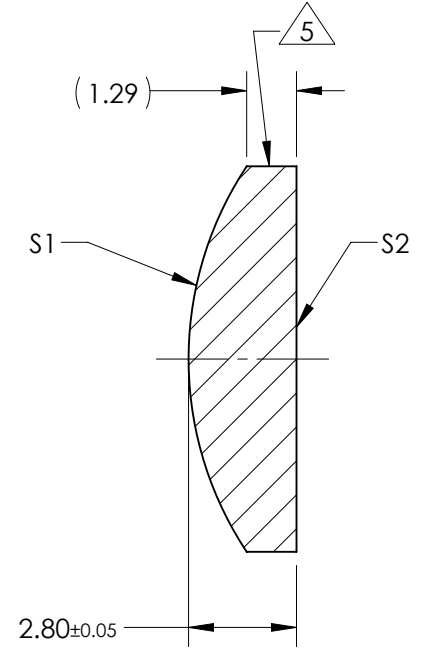
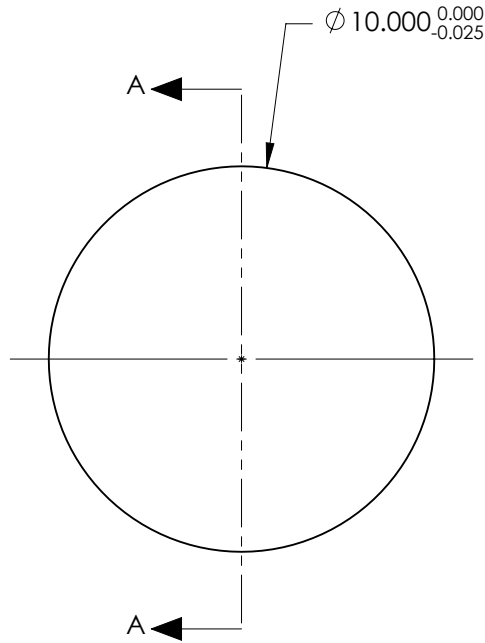

SECTION A-A

**FOR INFORMATION ONLY:
DO NOT MANUFACTURE
PARTS TO THIS DRAWING**

| | S1 | S2 |
|-------------------------|------------|------------|
| SHAPE | CONVEX | PLANO |
| RADIUS | 9.05 | INFINITY |
| SURFACE QUALITY | 40 - 20 | 40 - 20 |
| MIN CLEAR APERTURE | ∅ 9.00 | ∅ 9.00 |
| MIN COATING APERTURE | ∅ 9.00 | ∅ 9.00 |
| POWER AT 632.8nm | 3.00 RINGS | 3.00 RINGS |
| IRREGULARITY AT 632.8nm | 0.50 RINGS | 0.50 RINGS |

SPECIFICATIONS SUBJECT TO CHANGE WITHOUT NOTICE
DIMENSIONS ARE FOR REFERENCE ONLY

EO® Edmund Optics®

| | | | |
|------------------------|----|--------|--|
| THIRD ANGLE PROJECTION | | TITLE | 10.0mm Dia. x 17.5mm FL, NIR I Coated, Plano-Convex Lens |
| ALL DIMS IN | mm | DWG NO | 38336 |
| | | | SHEET 1 OF 1 |