

NOTES:

1. SUBSTRATE MATERIAL:  
FLOAT GLASS
2. COATING (APPLY ACROSS CLEAR APERTURE):  
S1: BARE GOLD  
S2: NONE
3. BLAZE ANGLE: 19° 23'  
NOMINAL BLAZE WAVELENGTH: 800nm  
ABSOLUTE DIFFRACTION EFFICIENCY: 60-85%
4. EDGES GROUND
5. RoHS COMPLIANT

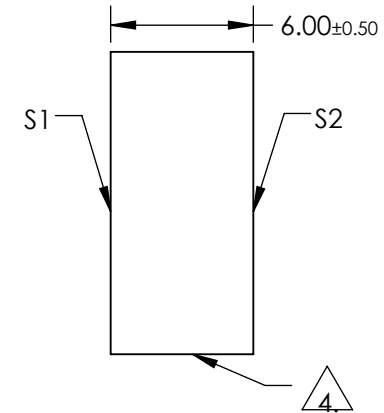
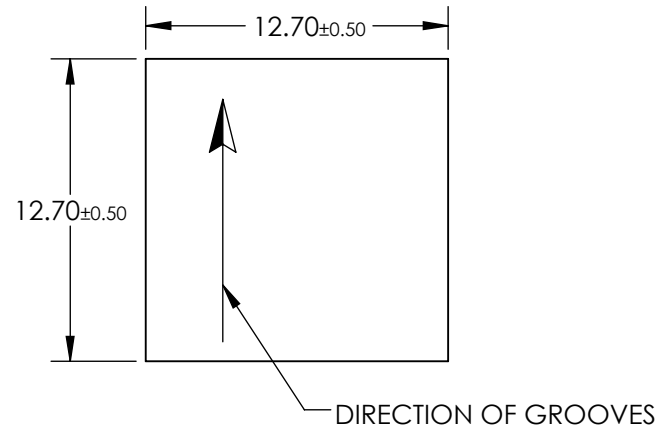
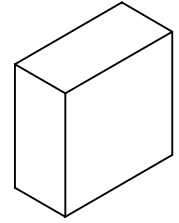

**FOR INFORMATION ONLY:  
DO NOT MANUFACTURE  
PARTS TO THIS DRAWING**

SPECIFICATIONS SUBJECT TO CHANGE WITHOUT NOTICE  
DIMENSIONS ARE FOR REFERENCE ONLY

**EO**® Edmund Optics®

	S1	S2	THIRD ANGLE PROJECTION		TITLE	GRATING GOLD 12.7mm 830G/mm	
SHAPE	PLANO	PLANO	ALL DIMS IN	mm	DWG NO	43849	SHEET 1 OF 1
CLEAR APERTURE	11.43 x 11.43	11.43 x 11.43					