

NOTES:

1. SUBSTRATE MATERIAL:
FLOAT GLASS
2. COATING (APPLY ACROSS CLEAR APERTURE):
S1: BARE ALUMINUM
S2: NONE
3. WAVELENGTH RANGE: 400-700nm
ABSOLUTE DIFFRACTION EFFICIENCY: 45-65%
GROOVE DENSITY: 1800 grooves/mm
4. EDGES GROUND
5. RoHS: COMPLIANT

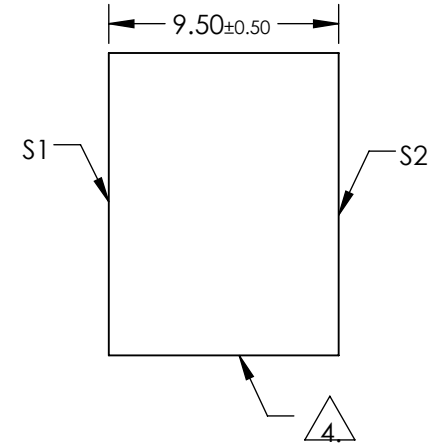
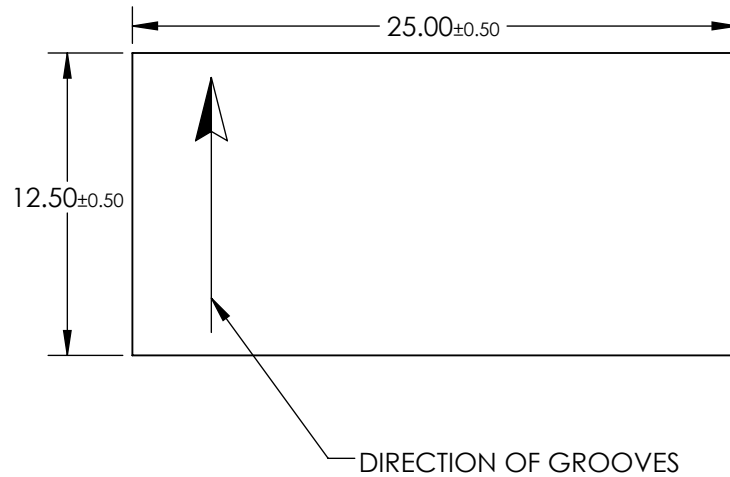
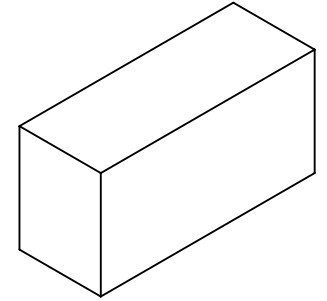

SPECIFICATIONS SUBJECT TO CHANGE WITHOUT NOTICE
DIMENSIONS ARE FOR REFERENCE ONLY

**FOR INFORMATION ONLY:
DO NOT MANUFACTURE
PARTS TO THIS DRAWING**

EO® Edmund Optics®

	S1	S2	THIRD ANGLE PROJECTION		TITLE	GRATING HOLO 1800GR VIS 12.5 X 25	
SHAPE	PLANO	PLANO	ALL DIMS IN	mm	DWG NO	43221	SHEET 1 OF 1
CLEAR APERTURE	11.25 x 22.5	11.25 x 22.5					