

NOTES:

1. SUBSTRATE:
CRYSTAL QUARTZ
2. COATING (APPLY ACROSS CLEAR APERTURE)
S1 & S2: R(ABS) <0.25% @ 405nm
DAMAGE THRESHOLD: 3.5 J/cm² @10ns @ 1064nm
3. SURFACE S1 TO BE PARALLEL TO SURFACE S2 TO WITHIN <0.5 arcsec
4. RETARDANCE: $\lambda/4 \pm \lambda/200$
5. TRANSMITTED WAVEFRONT: $\lambda/10$ FOR CENTRAL 80% OF CLEAR APERTURE
6. RoHS COMPLIANT

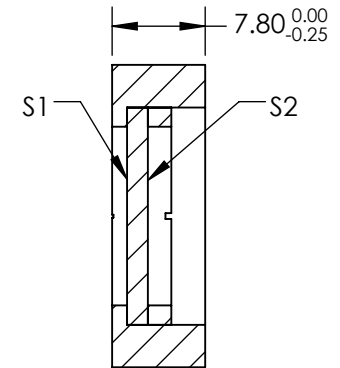
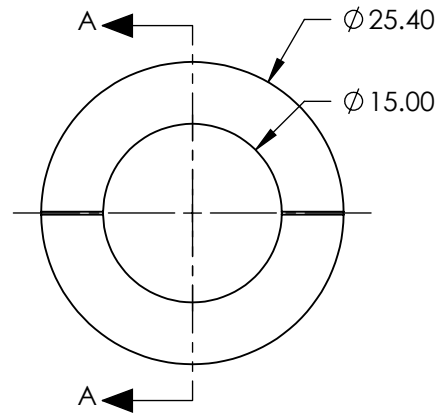
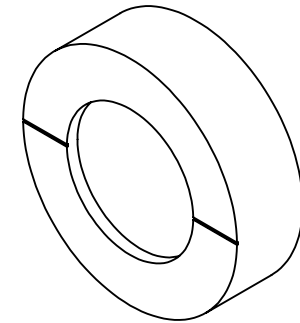
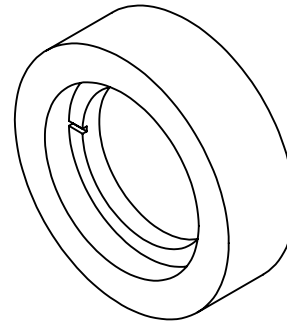

SECTION A-A

**FOR INFORMATION ONLY:
DO NOT MANUFACTURE
PARTS TO THIS DRAWING**

SPECIFICATIONS SUBJECT TO CHANGE WITHOUT NOTICE
DIMENSIONS ARE FOR REFERENCE ONLY

EO® Edmund Optics®

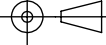
	S1	S2	THIRD ANGLE PROJECTION 	TITLE	Ø25.4mm, 405nm, $\lambda/4$ QUARTZ WAVEPLATE MULTIPLE ORDER	
CLEAR APERTURE	Ø15.0	Ø15.0		ALL DIMS IN	mm	DWG NO
SURFACE QUALITY	10-5	10-5				SHEET 1 OF 1