

NOTES:

1. SUBSTRATE MATERIAL:
ALUMINUM
2. FINISH (EXCEPT SURFACE S1):
BLACK ANODIZED
3. COATING (APPLY ACROSS CLEAR APERTURE)
S1: PROTECTED ALUMINUM
R(AVG) >85% from 0.4-0.7 μ m
R(AVG) >97% from 2 - 12 μ m

SURFACE ROUGHNESS: <100 Å RMS
4. FOCAL LENGTH TOLERANCE: \pm 1%
5. ROHS COMPLIANT

**FOR INFORMATION ONLY:
DO NOT MANUFACTURE
PARTS TO THIS DRAWING**

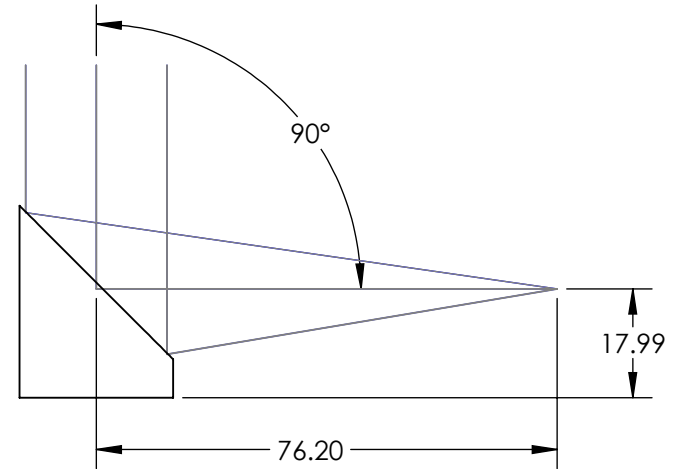
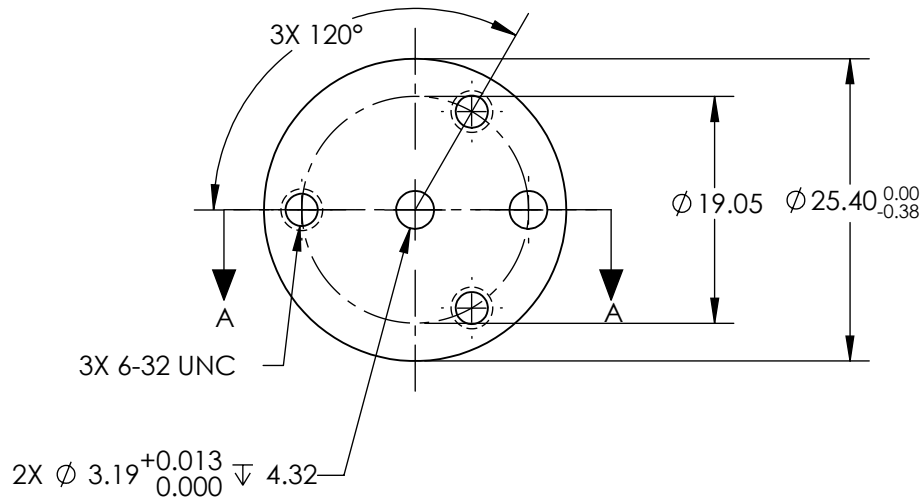
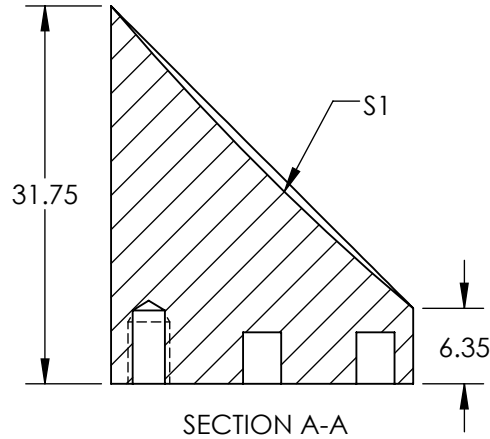
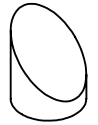

SPECIFICATIONS SUBJECT TO CHANGE WITHOUT NOTICE
DIMENSIONS ARE FOR REFERENCE ONLY

REV. A	S1	EFL	76.20		
SHAPE	PARABOLIC	PFL	38.10		
REFLECTIVE WAVEFRONT DISTORTION AT 632.8nm (RMS)	$\lambda/2$	THIRD ANGLE PROJECTION		TITLE	Ø25.4 X 76.2mm EFL 90° OAP PROTECTED ALUMINUM MIRROR 100Å
SURFACE FIGURE AT 632.8nm (RMS)	$\lambda/4$	ALL DIMS IN	mm	DWG NO	
CLEAR APERTURE	90%				SHEET 1 OF 1
BEVEL	PROTECTIVE AS NEEDED				