

NOTES:

1. SUBSTRATE MATERIAL:
N-BK7
2. COATING (APPLY ACROSS CLEAR APERTURE)
S1 & S2:
VIS 0
R(AVG) ≤ 0.4% FROM 425-675nm @ 0° AOI
3. FINE GROUND SURFACE
4. POWER, IRREGULARITY, AND SURFACE QUALITY SPECIFICATIONS APPLY ACROSS CLEAR APERTURE
5. FOCAL LENGTH TOLERANCE: ±1%
6. PLANO AXIS WEDGE TOLERANCE: < 5 ARCMIN
POWER AXIS WEDGE TOLERANCE: < 5 ARCMIN
7. RoHS COMPLIANT

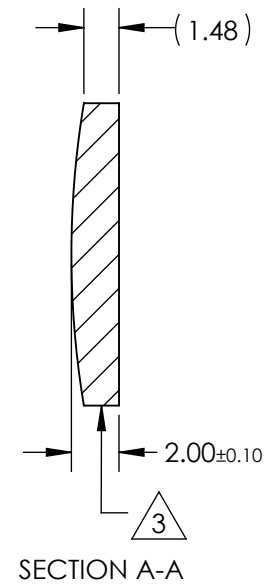
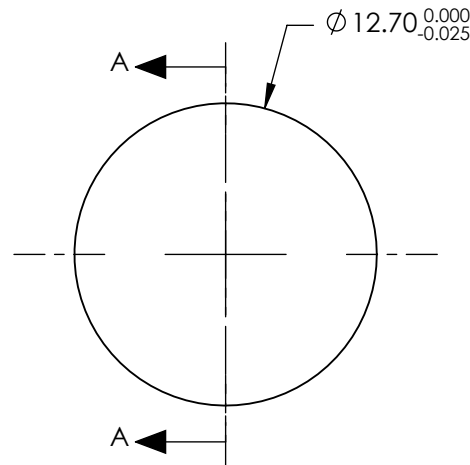

**FOR INFORMATION ONLY:
DO NOT MANUFACTURE
PARTS TO THIS DRAWING**

REV. A	S1	S2
SHAPE	CONVEX	PLANO
RADIUS	38.76	∞
SURFACE QUALITY	40 - 20	40 - 20
CLEAR APERTURE	Ø11.43	Ø11.43
COATING APERTURE	Ø11.43	Ø11.43
POWER AT 632.8nm	1.5 WAVES PV	1.5 WAVES PV
IRREGULARITY AT 632.8nm	0.25 WAVE PV	0.25 WAVE PV
BEVEL	PROTECTIVE AS NEEDED	PROTECTIVE AS NEEDED

SPECIFICATIONS SUBJECT TO CHANGE WITHOUT NOTICE
DIMENSIONS ARE FOR REFERENCE ONLY

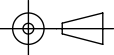
EFL	75mm	 Edmund Optics®	
BFL	73.68mm		
THIRD ANGLE PROJECTION		TITLE	LENS CYL SHAPING 12.7mm DIA. X 75mm FL VIS 0
ALL DIMS IN	mm	DWG NO	34649
			SHEET 1 OF 1