

NOTES:

1. SUBSTRATE: UV GRADE FUSED SILICA
2. COATING (APPLY ACROSS COATING APERTURE)
S1 & S2: NONE
3. SURFACE S2 TO BE PARALLEL TO SURFACE S1 WITHIN <5 ARCSEC
4. FINE GRIND SURFACE
5. RoHS COMPLIANT

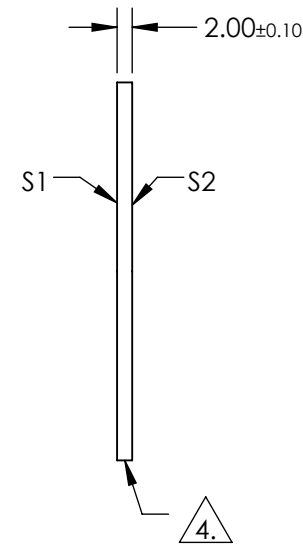
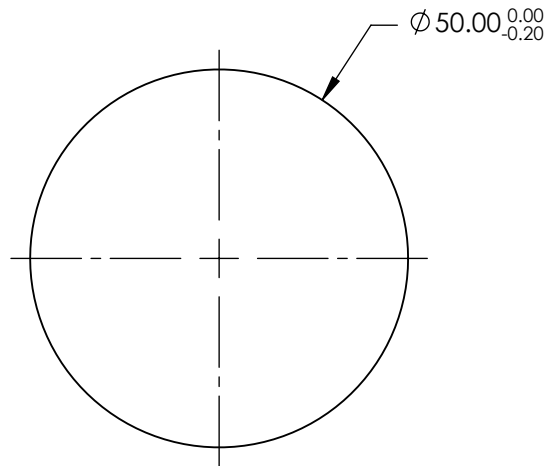

**FOR INFORMATION ONLY:
DO NOT MANUFACTURE
PARTS TO THIS DRAWING**

SPECIFICATIONS SUBJECT TO CHANGE WITHOUT NOTICE
DIMENSIONS ARE FOR REFERENCE ONLY

	S1	S2
SHAPE	PLANO	PLANO
SURFACE QUALITY	20-10	20-10
CLEAR APERTURE	Ø40.00	Ø40.00
BEVEL	PROTECTIVE AS NEEDED	PROTECTIVE AS NEEDED

THIRD ANGLE PROJECTION

ALL DIMS IN mm

EO® Edmund Optics®

TITLE

50mm DIA., 2mm THICK, UNCOATED λ/10
FUSED SILICA WINDOW

DWG NO

34600

SHEET
1 OF 1