

NOTES:

1. SUBSTRATE:
BOROFLOAT®
2. COATING SPECIFICATION:
S1: Protected Gold (700-1000nm)
R(AVG) >96% @ 700 - 2000nm
R(AVG) >96% @ 2000 - 10,000nm

3. FINE GROUND SURFACE

4. ROHS COMPLIANT

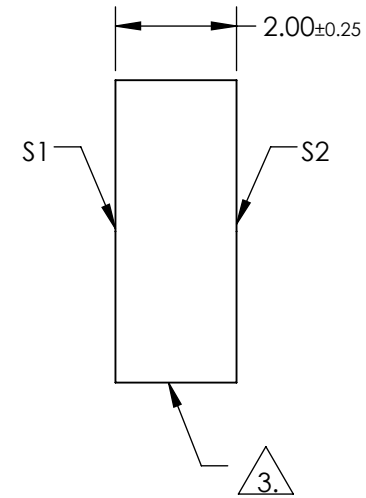
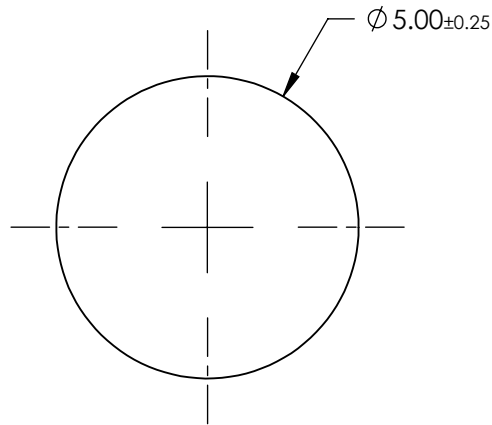
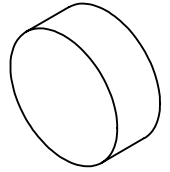

**FOR INFORMATION ONLY:
DO NOT MANUFACTURE
PARTS TO THIS DRAWING**

SPECIFICATIONS SUBJECT TO CHANGE WITHOUT NOTICE
DIMENSIONS ARE FOR REFERENCE ONLY

	S1	S2
SHAPE	PLANO	PLANO
SURFACE QUALITY	60-40	COMMERCIAL POLISH
CLEAR APERTURE	Ø4.25	N/A
BEVEL	PROTECTIVE AS NEEDED	PROTECTIVE AS NEEDED



ALL DIMS IN mm

EO® Edmund Optics®

TITLE

5mm Dia. Protected Gold, λ/4 Mirror

DWG NO

48410

SHEET
1 OF 1