

NOTES:

- 1. ELEMENT A: 32317
- 2. ELEMENT B: 32317

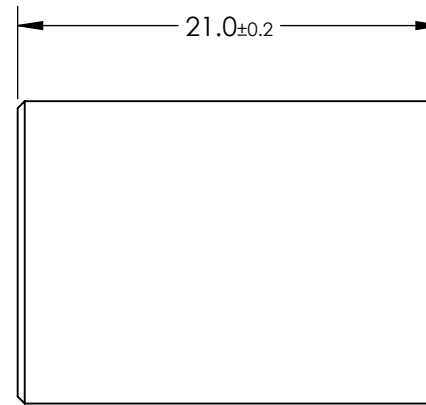
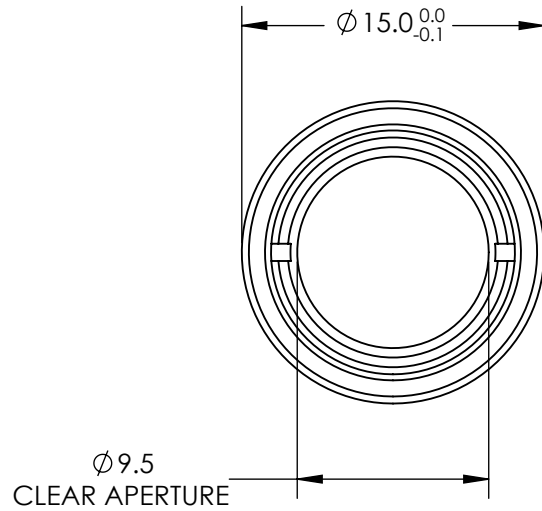
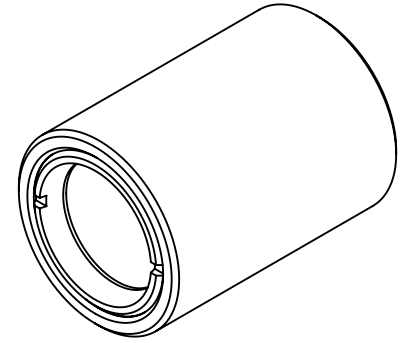

SPECIFICATIONS SUBJECT TO CHANGE WITHOUT NOTICE
DIMENSIONS ARE FOR REFERENCE ONLY

**FOR INFORMATION ONLY:
DO NOT MANUFACTURE
PARTS TO THIS DRAWING**

 **Edmund Optics®**

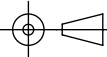
THIRD ANGLE PROJECTION 		TITLE	1:1 WITH 50mm AND 50mm EFL ACHROMATS, 15mm ACHROMATIC PAIR	
ALL DIMS IN	mm	DWG NO	55272	SHEET 1 OF 1