

NOTES:

1. ELEMENT A: 32309
2. ELEMENT B: 32311

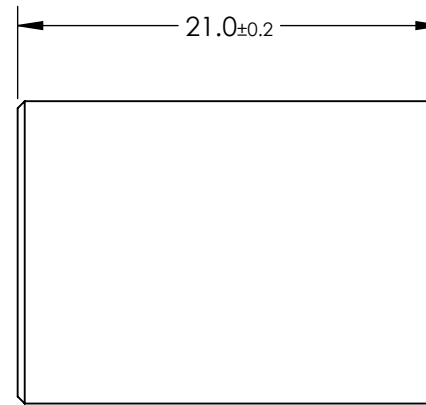
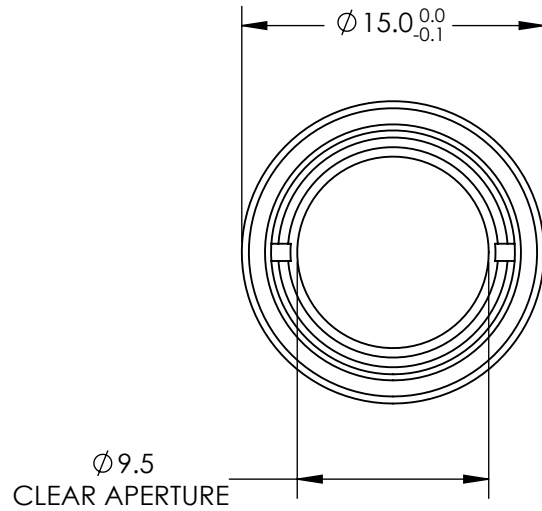
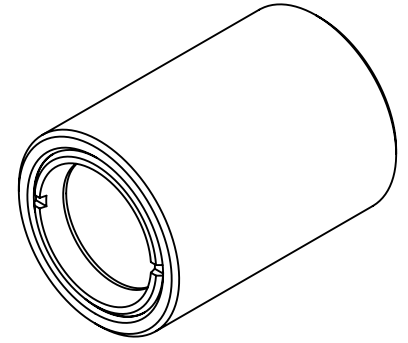

SPECIFICATIONS SUBJECT TO CHANGE WITHOUT NOTICE  
DIMENSIONS ARE FOR REFERENCE ONLY

**FOR INFORMATION ONLY:  
DO NOT MANUFACTURE  
PARTS TO THIS DRAWING**

**EO**® Edmund Optics®

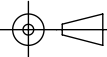
THIRD ANGLE PROJECTION 		TITLE	1:1.25 WITH 20mm AND 25mm EFL ACHROMATS, 15mm ACHROMATIC PAIR	
ALL DIMS IN	mm	DWG NO	43996	SHEET 1 OF 1