

NOTES:

1. ELEMENT A: 32321
2. ELEMENT B: 32327

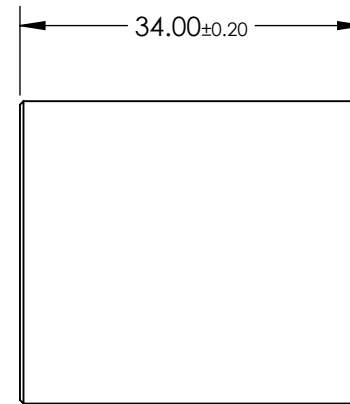
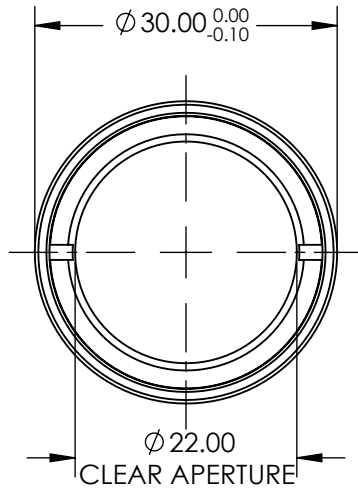
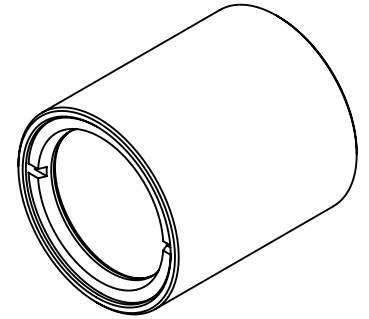

SPECIFICATIONS SUBJECT TO CHANGE WITHOUT NOTICE
DIMENSIONS ARE FOR REFERENCE ONLY

**FOR INFORMATION ONLY:
DO NOT MANUFACTURE
PARTS TO THIS DRAWING**

EO® Edmund Optics®

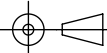
THIRD ANGLE PROJECTION 		TITLE	1:2.5 WITH 40mm AND 100mm EFL ACHROMATS, 30mm ACHROMATIC PAIR	
ALL DIMS IN	mm	DWG NO	46010	SHEET 1 OF 1