

NOTES:

1. SUBSTRATE: Float Glass
2. ROHS COMPLIANT
3. COATING (APPLY ACROSS CLEAR APERTURE)

S1: Ravg >98% @ 450 - 2000nm
 Ravg >98% @ 2000 - 10,000nm
 S2: NONE

4. FINE GRIND SURFACE

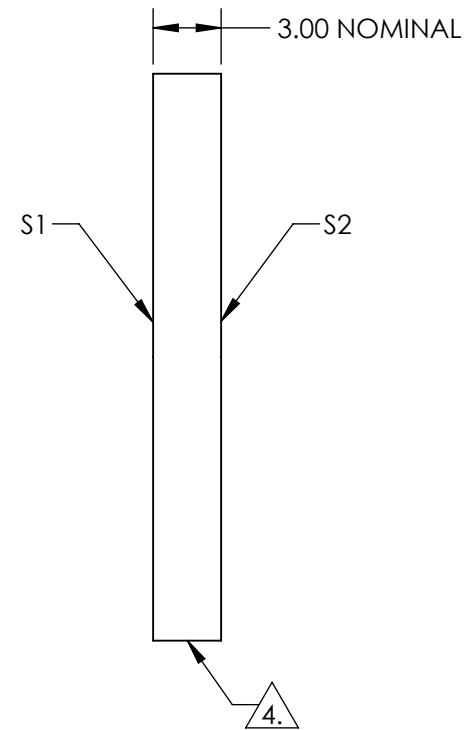
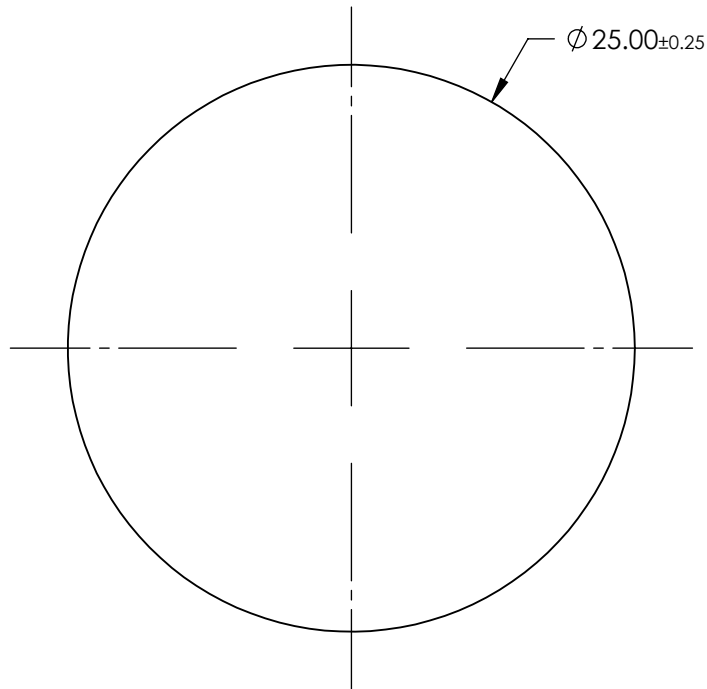
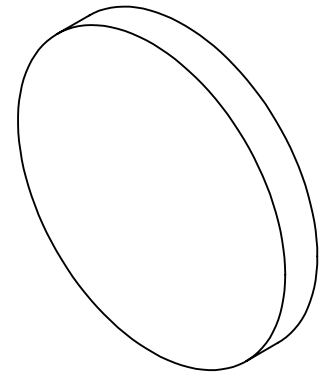

**FOR INFORMATION ONLY:
 DO NOT MANUFACTURE
 PARTS TO THIS DRAWING**

SPECIFICATIONS SUBJECT TO CHANGE WITHOUT NOTICE
 DIMENSIONS ARE FOR REFERENCE ONLY

EO® Edmund Optics®

	S1	S2
SURFACE QUALITY	60-40	60-40
SURFACE FLATNESS	4 - 6λ	4 - 6λ
BEVEL	PROTECTED AS NEEDED	PROTECTED AS NEEDED

THIRD ANGLE PROJECTION

ALL DIMS IN mm

TITLE

25mm Dia Silver, 4-6λ Mirror

DWG NO

89482

SHEET
1 OF 1