

NOTES:

1. SUBSTRATE:
FLOAT GLASS

2. FINE GROUND SURFACE

3. RoHS COMPLIANT

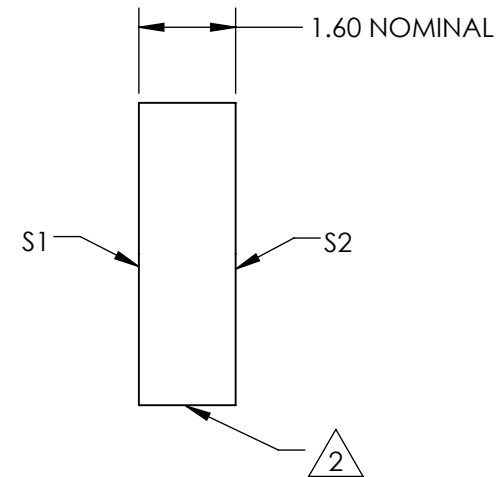
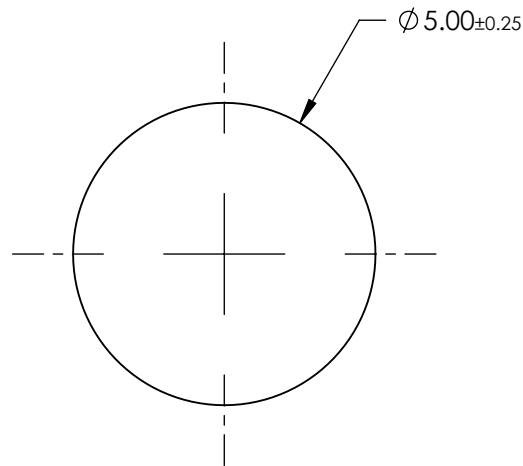
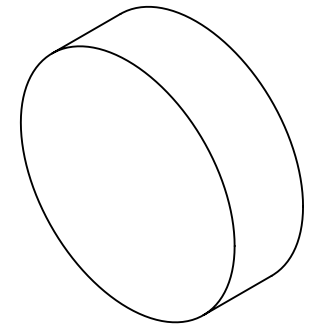

**FOR INFORMATION ONLY:
DO NOT MANUFACTURE
PARTS TO THIS DRAWING**

SPECIFICATIONS SUBJECT TO CHANGE WITHOUT NOTICE
DIMENSIONS ARE FOR REFERENCE ONLY

EO® Edmund Optics®

	S1	S2	THIRD ANGLE PROJECTION		TITLE	5mm DIAMETER 120 GRIT GROUND GLASS DIFFUSER	
SHAPE	PLANO	PLANO	ALL DIMS IN	mm	DWG NO	83416	SHEET 1 OF 1
WAVELENGTH RANGE	350 - 2000nm	350 - 2000nm					
BEVEL	PROTECTIVE AS NEEDED	PROTECTIVE AS NEEDED					