

NOTES:

1. SUBSTRATE MATERIAL:
FUSED SILICA
2. COATING - NONE
3. FINISH: POLISHED
4. SPHERICITY:
 $\pm 2.5\mu\text{m}$
5. RoHS COMPLIANT

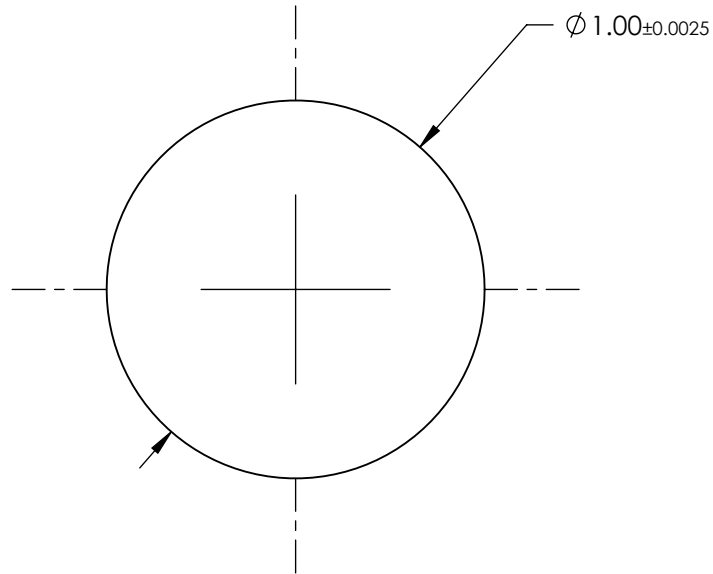

SPECIFICATIONS SUBJECT TO CHANGE WITHOUT NOTICE
DIMENSIONS ARE FOR REFERENCE ONLY

**FOR INFORMATION ONLY:
DO NOT MANUFACTURE
PARTS TO THIS DRAWING**

EO® Edmund Optics®

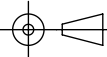
THIRD ANGLE PROJECTION 		TITLE	1.0mm DIAMETER, FUSED SILICA BALL LENS	
ALL DIMS IN	mm	DWG NO	67380	SHEET 1 OF 1