

NOTES:

1. SUBSTRATE:
N-BK7
2. S2 TO BE PARALLEL WITH S1 TO <1 arcmin
3. COATING (APPLY ACROSS CLEAR APERTURE)
S1 & S2: RABS <0.25% @ 785nm

 4. FINE GRIND SURFACE

5. RoHS COMPLIANT

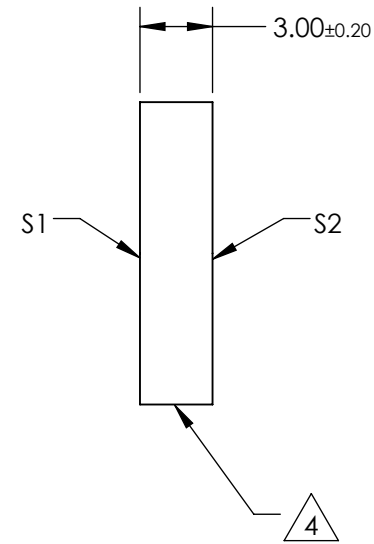
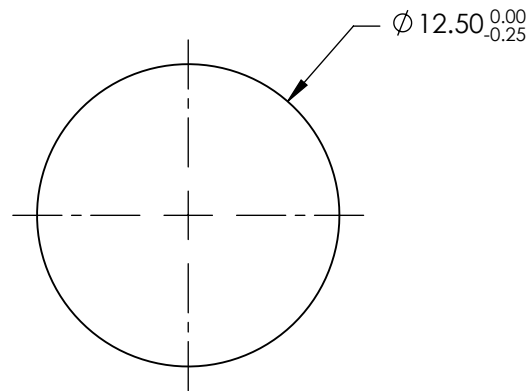
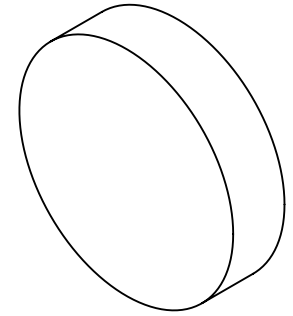

**FOR INFORMATION ONLY:
DO NOT MANUFACTURE
PARTS TO THIS DRAWING**

SPECIFICATIONS SUBJECT TO CHANGE WITHOUT NOTICE
DIMENSIONS ARE FOR REFERENCE ONLY

 [®] Edmund Optics[®]

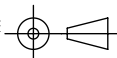
	S1	S2	 THIRD ANGLE PROJECTION		TITLE	12.5mm DIAMETER, 785nm V-COAT, λ/4 N-BK7 WINDOW	
SHAPE	PLANO	PLANO			DWG NO	64048	SHEET
SURFACE QUALITY	60-40	60-40	ALL DIMS IN	mm			
BEVEL	PROTECTIVE AS NEEDED	PROTECTIVE AS NEEDED					