

NOTES:

1. SUBSTRATE:
N-BK7
2. S2 TO BE PARALLEL WITH S1 TO <1 arcmin
3. COATING (APPLY ACROSS CLEAR APERTURE)
S1 & S2: RABS <0.25% @ 633nm

△ 4. FINE GRIND SURFACE

5. RoHS COMPLIANT

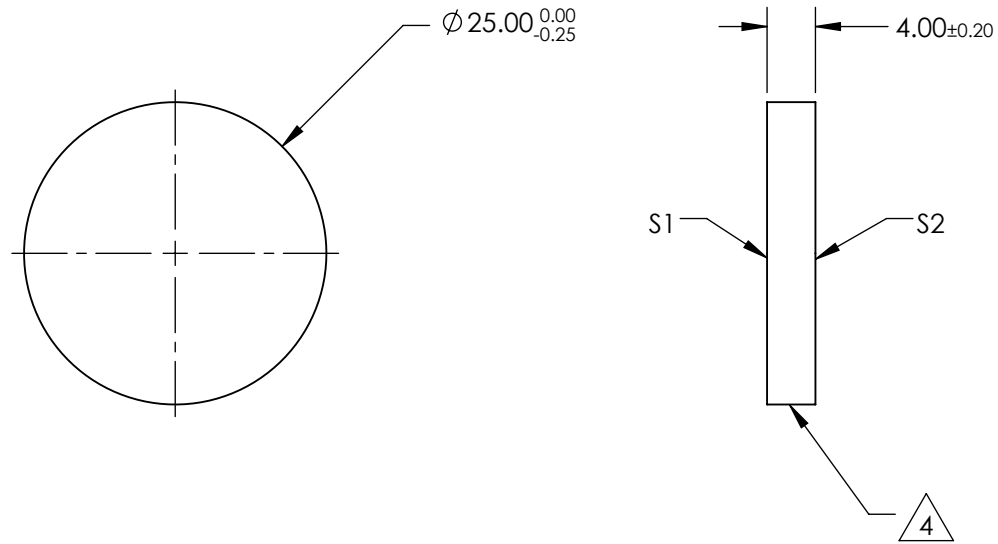
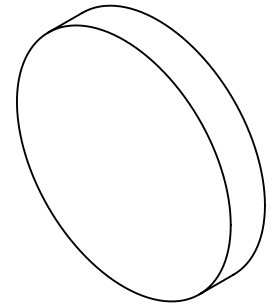

**FOR INFORMATION ONLY:
DO NOT MANUFACTURE
PARTS TO THIS DRAWING**

SPECIFICATIONS SUBJECT TO CHANGE WITHOUT NOTICE
DIMENSIONS ARE FOR REFERENCE ONLY

EO® Edmund Optics®

	S1	S2	THIRD ANGLE PROJECTION		TITLE	25mm DIAMETER, 633nm V-COAT, λ/4 N-BK7 WINDOW	
SHAPE	PLANO	PLANO	ALL DIMS IN	mm	DWG NO	49141	SHEET 1 OF 1
SURFACE QUALITY	60-40	60-40					
BEVEL	PROTECTIVE AS NEEDED	PROTECTIVE AS NEEDED					