

NOTES:

1. ELEMENT A: 45211
2. ELEMENT B: 32323

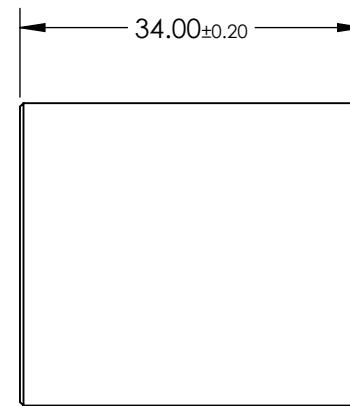
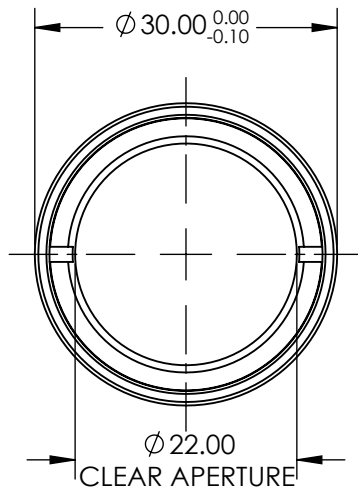
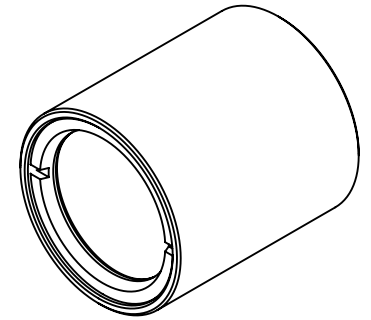

SPECIFICATIONS SUBJECT TO CHANGE WITHOUT NOTICE  
DIMENSIONS ARE FOR REFERENCE ONLY

**FOR INFORMATION ONLY:  
DO NOT MANUFACTURE  
PARTS TO THIS DRAWING**

**EO**® Edmund Optics®

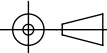
THIRD ANGLE PROJECTION 		TITLE	1:1.67 WITH 30mm AND 50mm EFL ACHROMATS, 30mm ACHROMATIC PAIR	
ALL DIMS IN	mm	DWG NO	46004	SHEET 1 OF 1