

NOTES:

- 1. SUBSTRATE MATERIAL: Float Glass
- 2. ROHS COMPLIANT
- 3. COATING (APPLY ACROSS CLEAR APERTURE)

S1: R(avg) >96% @ 700 - 2000
 R(avg) >96% @ 2000 - 10000nm
 S2: NONE

 FINE GRIND SURFACE

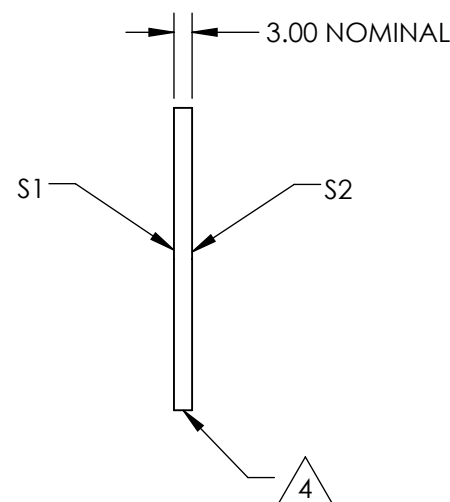
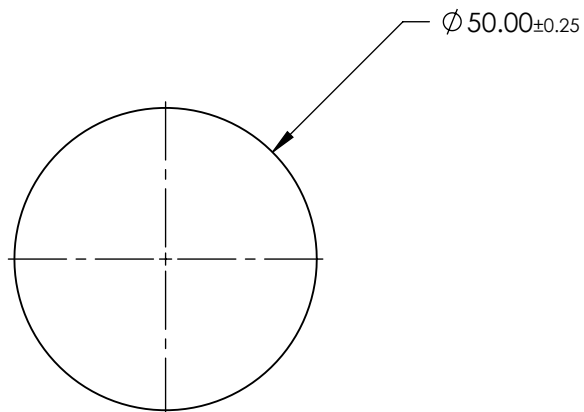
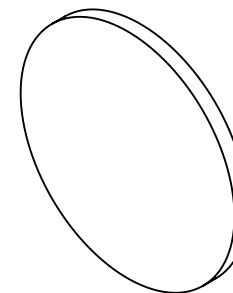

SPECIFICATIONS SUBJECT TO CHANGE WITHOUT NOTICE
 DIMENSIONS ARE FOR REFERENCE ONLY

**FOR INFORMATION ONLY:
 DO NOT MANUFACTURE
 PARTS TO THIS DRAWING**

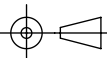

REV. A	S1	S2	THIRD ANGLE PROJECTION 		TITLE	50mm Dia Protected Gold, 4-6λ Mirror	
SURFACE QUALITY	60-40	60-40	ALL DIMS IN	mm	DWG NO	45615	SHEET 1 OF 1
SURFACE FLATNESS	4 - 6λ	4 - 6λ					
BEVEL	PROTECTIVE AS NEEDED	PROTECTIVE AS NEEDED					