

NOTES:

1. SUBSTRATE MATERIAL:
N-BK7
2. COATING - NONE
3. FINISH: POLISHED
4. SPHERICITY:
5 μ m
5. RoHS COMPLIANT

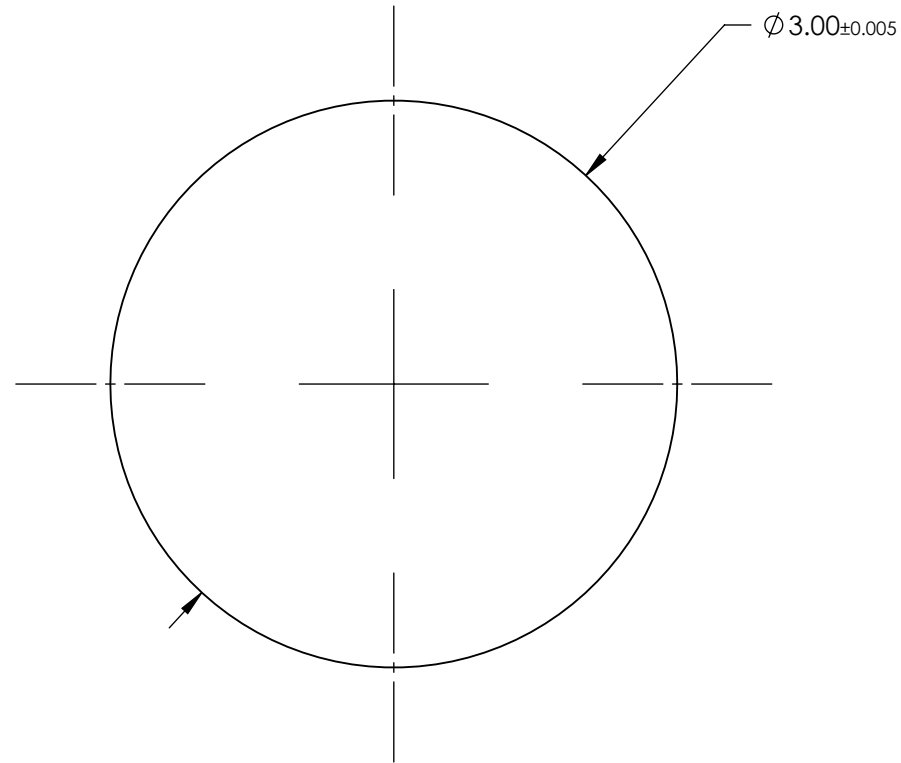

SPECIFICATIONS SUBJECT TO CHANGE WITHOUT NOTICE
DIMENSIONS ARE FOR REFERENCE ONLY

**FOR INFORMATION ONLY:
DO NOT MANUFACTURE
PARTS TO THIS DRAWING**

 **Edmund Optics®**

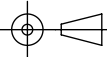
THIRD ANGLE PROJECTION 		TITLE	3.0mm DIAMETER, N-BK7 BALL LENS	
ALL DIMS IN	mm	DWG NO	43711	SHEET 1 OF 1