

NOTES:

- 1. SUBSTRATE MATERIAL: Float Glass
- 2. ROHS COMPLIANT
- 3. COATING (APPLY ACROSS CLEAR APERTURE)

S1: R(avg) >95% @ 450 - 650nm

S2: NONE

 FINE GRIND SURFACE

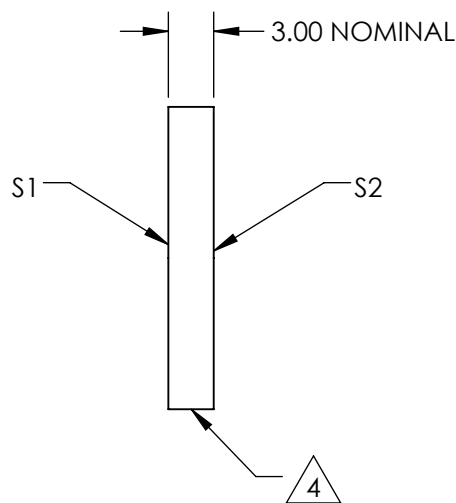
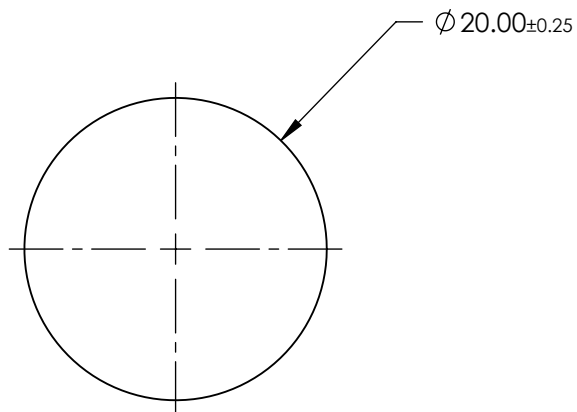
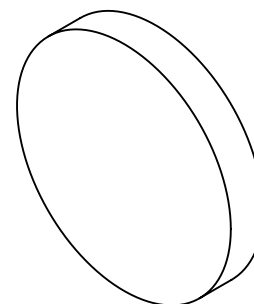

SPECIFICATIONS SUBJECT TO CHANGE WITHOUT NOTICE
DIMENSIONS ARE FOR REFERENCE ONLY

**FOR INFORMATION ONLY:
DO NOT MANUFACTURE
PARTS TO THIS DRAWING**

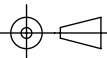

REV. A	S1	S2	THIRD ANGLE PROJECTION 		TITLE	20mm Dia Enhanced Aluminum, 4-6λ Mirror	
SURFACE QUALITY	60-40	60-40	ALL DIMS IN	mm	DWG NO	32944	SHEET 1 OF 1
SURFACE FLATNESS	4 - 6λ	4 - 6λ					
BEVEL	PROTECTIVE AS NEEDED	PROTECTIVE AS NEEDED					