

NOTES:

1. SUBSTRATE MATERIAL: BOROFLOAT®

2. COATING (APPLY ACROSS CLEAR APERTURE)

S1: Protected Aluminum

R(avg) >85% @ 400 - 700nm

R(avg) >90% @ 400 - 2000nm

DENSITY LIMIT: 0.3 J/cm<sup>2</sup> @ 532nm & 1064nm, 10ns

S2: NONE

3. FINE GRIND SURFACE

4. RoHS COMPLIANT

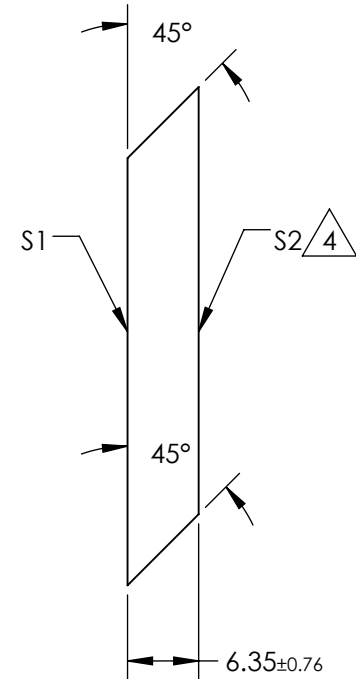
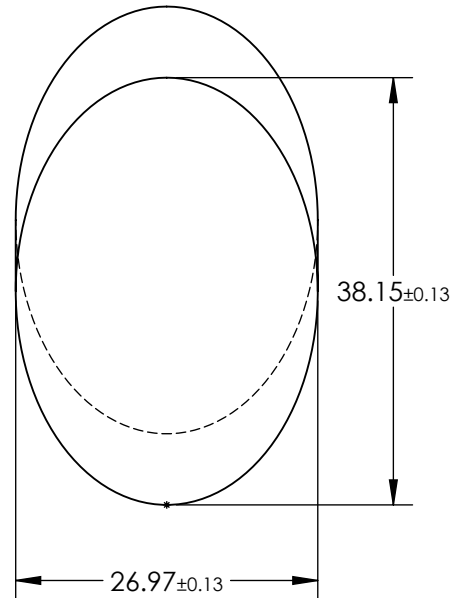

**FOR INFORMATION ONLY:  
DO NOT MANUFACTURE  
PARTS TO THIS DRAWING**

SPECIFICATIONS SUBJECT TO CHANGE WITHOUT NOTICE  
DIMENSIONS ARE FOR REFERENCE ONLY

REV. A	S1	S2
TYPE	PLANO	PLANO
WAVELENGTH RANGE (nm)	400 - 2000	400 - 2000
SURFACE QUALITY	60-40	N/A
SURFACE FLATNESS	$\lambda/8$	N/A
BEVEL	PROTECTIVE AS NEEDED	PROTECTIVE AS NEEDED

THIRD ANGLE  
PROJECTION

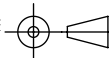

ALL DIMS IN

mm

**EO**® Edmund Optics®

TITLE

26.97mm, MINOR AXIS PROTECTED ALUM.  
ELLIPTICAL MIRROR

DWG NO

30837

SHEET  
1 OF 1