

NOTES:

1. SUBSTRATE MATERIAL:
N-BK7

2. ROHS COMPLIANT

3. COATING (APPLY ACROSS CLEAR APERTURE)

S1: 60% R $\pm 5\%$ @ 550nm
40% T $\pm 5\%$ @ 550nm

S2: AR R(avg) $\leq 1\%$, R(abs) $\leq 2\%$ @ 400 - 700nm

4. CUT WITH 0.25mm MAXIMUM EDGE CHIP

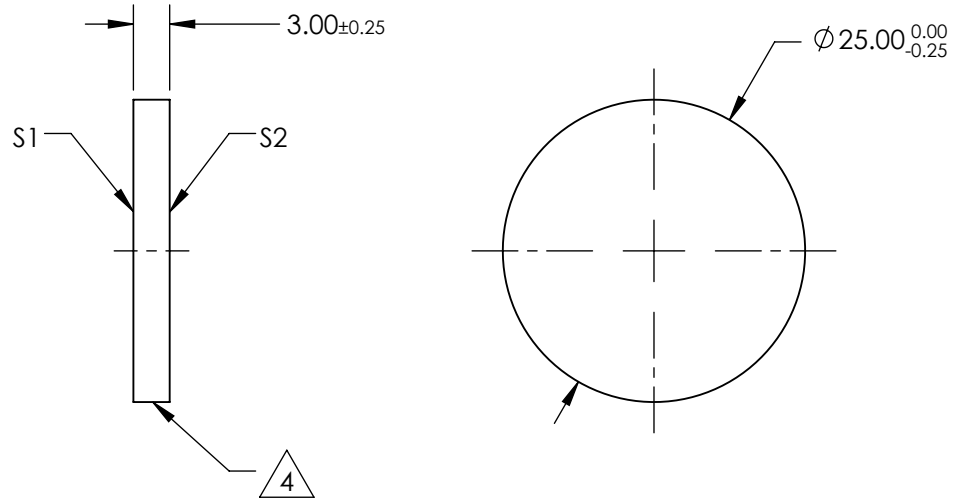

**FOR INFORMATION ONLY:
DO NOT MANUFACTURE
PARTS TO THIS DRAWING**

SPECIFICATIONS SUBJECT TO CHANGE WITHOUT NOTICE
DIMENSIONS ARE FOR REFERENCE ONLY

REV. A	S1	S2
SHAPE	PLANO	PLANO
ANGLE OF INCIDENCE	45°	45°
SURFACE QUALITY	60-40	60-40
SURFACE FLATNESS	1λ	1λ

THIRD ANGLE PROJECTION

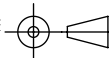

ALL DIMS IN

mm

EO® Edmund Optics®

TITLE

Ø25mm, 40 R/60 T, PLATE BEAMSPLITTER

DWG NO

68403

SHEET
1 OF 1