

NOTES:

1. SUBSTRATE MATERIAL:
N-BK7

2. ROHS COMPLIANT

3. SURFACE S1 TO BE PARALLEL WITH SURFACE S2 TO WITHIN ≤ 3 ARCMIN

4. COATING (APPLY ACROSS CLEAR APERTURE)

S1: 20% R $\pm 5\%$ @ 550nm
80% T $\pm 5\%$ @ 550nm

S2: AR R(avg) $\leq 1\%$, R(abs) $\leq 2\%$ @ 700 - 1100nm

5.  CUT WITH 0.25mm MAXIMUM EDGE CHIP

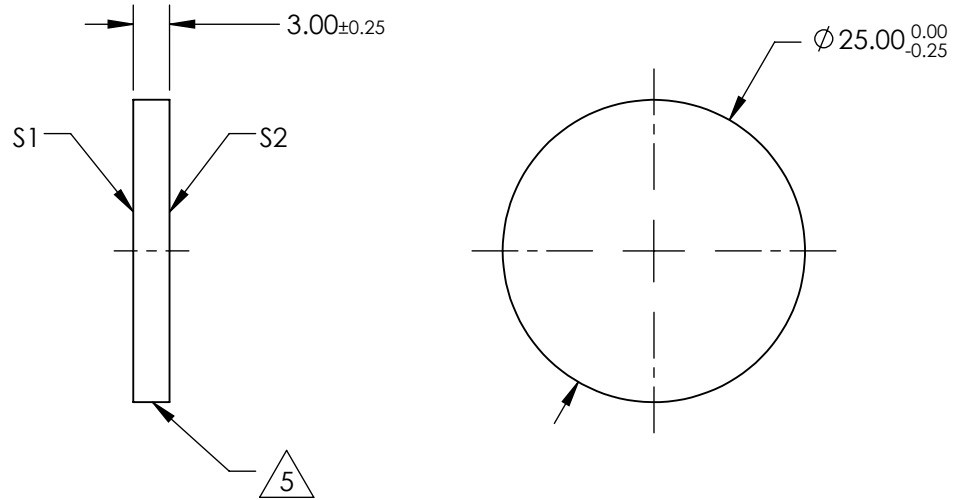

**FOR INFORMATION ONLY:
DO NOT MANUFACTURE
PARTS TO THIS DRAWING**

SPECIFICATIONS SUBJECT TO CHANGE WITHOUT NOTICE
DIMENSIONS ARE FOR REFERENCE ONLY

REV. A	S1	S2
SHAPE	PLANO	PLANO
ANGLE OF INCIDENCE	45°	45°
SURFACE QUALITY	60-40	60-40
SURFACE FLATNESS	1λ PER 25mm	1λ PER 25mm

THIRD ANGLE PROJECTION

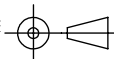

ALL DIMS IN

mm

 **Edmund Optics®**

TITLE

Ø25mm, 20 R/80 T, PLATE BEAMSPLITTER

DWG NO

68368

SHEET
1 OF 1